

## Two-Way Radio Communication Products

# END-USER PRICE LIST



GENESIS



RANGER



WIRELESS EAR RECEIVER



OVER-THE-HEAD HEADSET



HURRICANE



NECKLOOP



LIGHTSWORD



EXPLORER



LEGACY



BREEZE

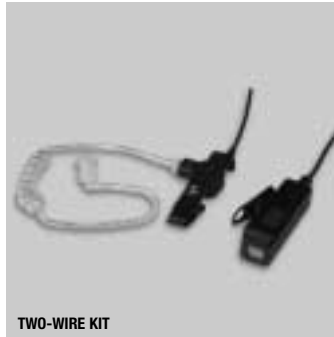

TWO-WIRE KIT



EVOLUTION

**Over 40 Years of Innovation in Demanding Applications**

**Surveillance Kits   Wireless Accessories   Headsets**  
**Remote Speaker Microphones   Tactical, Fire & Hazmat**  
**Communications Equipment   Racing Communication**  
**System   Replacement Parts**

**OTTO**  
COMMUNICATIONS®

**OTTO COMMUNICATIONS** Carpentersville, IL 60110, U.S.A.  
TOLL FREE 1.888.234.OTTO Phone 1.847.428.7171 Fax 1.847.428.1956  
E-Mail: [comsales@ottoeng.com](mailto:comsales@ottoeng.com) Internet: [www.ottoeng.com](http://www.ottoeng.com)

Publication #2005-01

## Notes

---

# Table of Contents

Conditions of Sale and 30 Day Evaluation Program . . . . .	4
Warranty Information and Return Policy . . . . .	5
Product Photos . . . . .	8
Connector Styles . . . . .	10
<b>PRODUCT (Contact OTTO direct for other radio configuration availability)</b>	
E.F. Johnson 5000/5100 . . . . .	12
Icom F3, F3S, F4, F4S, F4TR, F10, F20, IC-H2, IC4008, H6, J12, M5, U12, U6, 4088A . . . . .	14
Icom F3G, F3GS, F4G, F4GS. . . . .	15
Icom F11, F11S, F14, F21, F21S, F25, F33GS, F33GT, F43GS, F43GT, F43TR. . . . .	16
Icom F30G, F40G, F31GS, GT, M88 . . . . .	17
Icom F50, F51, F60, F61 . . . . .	18
Kenwood TK-260G/360G, 270G/370G, 2100/3100, 2160/3160, ProTalk, 3101 FreeTalk XL, 2102/3102 ProTalk, TK272G/372G, TK3130 ProTalk XLS, TK-3131 FreeTalk XLS, TK220/320,240/340, 240D/340D, 208/308, 430/431, 250/350/353,TK260-270, 360/370, 248/348, FRS: UBZ-LF14, UBZ-LH14, UBZ-GM14 . . . . .	19
Kenwood TK-480/481, 290/390/380/280, TK2140-/3140, TK2180/3180, TK5400, TK5210 . . . . .	21
M/A-Com EDACS 300P . . . . .	23
M/A-Com Monogram . . . . .	24
M/A-Com PCS. . . . .	25
M/A-Com KPC/Panther 500P . . . . .	26
M/A-Com MPA/MPD . . . . .	27
M/A-Com MRK . . . . .	28
M/A-Com Prism-LPE . . . . .	30
M/A-Com Jaguar 700P / P7100 / P7130 /P7150 / P5100 / P5130 / P5150. . . . .	32
Maxon SP120, SP130, SP140, SPI140, SP300, SP310, SP320, SP330, SP340, SL25, SL55, SL100K, SL55+ . . . . .	34
Maxon SP200, SP210, SL100 and Legacy Series-PL1145, PL2245, PL2215P, PL2245P, PL2415, PL2445, PL5161, PL5164 . . . . .	35
Maxon SP-2550/SP2850, SL70W Series, EP-4800, TP4800, TP4801 . . . . .	36
Motorola Spirit GT, Spirit GT+ . . . . .	37
Motorola SP10, SP21, XTN500, XTN600, PRO1150, PRO215, CP100, PMR446, XTN446, XU1100, CLS1110, CLS1410, XU2600, PR400. . . . .	38
Motorola GP300, SP50, P110, P1225/P1225LS, P200, LTS2000, CT250/CT450/CT450LS, GP308, GP68, GP88, PRO3150, PRO2150, MTH500, P040, P080, CT150, CP88, P2000, CP200, CP150, GP350, GTX . . . . .	39
Motorola EX500 / EX600, GL200, GP344/ GP388 . . . . .	41
Motorola HT750, HT1250, HT1250LS, HT1550XLS, HT1550, MTX850/MTX850LS, MTX8250/MTX8250LS, MTX950/MTX9250, GP328, GP338, PRO5150, PRO7150, PRO9150, GP140, GP320, GP340, GP360, GP380, GP640, GP680, GP1280 . . . . .	42
Motorola XTS3000/Astro, XTS2500/XTS5000, HT1000, MT2000, MTS2000, MTX1000, MTX8000, MTX838, MTX9000, MTX-LS, JT1000, GP900, EX500/EX600, GP388/GP344, Visar. . . . .	44
Motorola Saber/Astro, HT600, MT1000, MTX800, MTX Classic, MTX900 and P200 . . . . .	47
Motorola Public Safety Special Accessories. . . . .	48
Relm Wireless DPH, EPH, EPU, EPV, EPI, GPH, LPH, LPU, LPX . . . . .	49
Tait . . . . .	50
Thales 25. . . . .	52
Vertex/Yaesu VX-10, VX-300, VXF-1. . . . .	53
Vertex/Yaesu VX-310 . . . . .	54
Vertex/Yaesu VX-210, VX210A, VX-400, VX-150, VX-160, VX-180, VX-410, VX-420 . . . . .	55
Vertex/Yaesu VX-500, VX-510V, VX-520U, VX-510L, VX-200 . . . . .	56
Vertex/Yaesu VX-530 and VX-537 . . . . .	57
Vertex/Yaesu VX-600, VX-800, VX-900. . . . .	58
Cellular & Miscellaneous Accessories . . . . .	59
Dispatch Communication Equipment . . . . .	60
Racing Communications Equipment . . . . .	61
Replacement parts 2 Wire Field Repairable Kits. . . . .	63
Replacement Earphones & Ear Insert Options . . . . .	66
Replacement Parts-Headsets . . . . .	67
Replacement Parts-Evolution Speaker Microphones . . . . .	69
Replacement Parts-Genesis Speaker Microphones . . . . .	73

Refer to OTTO's website ([www.ottoeng.com](http://www.ottoeng.com)) for the most up to date product and pricing information.

CONNECTORS

MOTOROLA

E.F. JOHNSON

RELM WIRELESS

ICOM

TAIT

KENWOOD

THALES

M/A-COM

VERTEX/YAESU

MAXON

OTHER

## Conditions of Sale

---

- 1.) All prices listed are in U.S. Dollars. Minimum order \$50.00
- 2.) Payment terms: Net 30 Days, subject to prior approval.
- 3.) Discount policy: Based on OTTO's competitive pricing, the following discount schedule will apply:

<b>0-99 Units</b>	<b>0% Discount</b>
<b>100-499 Units</b>	<b>5% Discount</b>
<b>500+ Units</b>	<b>10% Discount</b>

Note: Part numbers can be mixed with a minimum of 25 pieces per item. Minimum \$15.00 Resale Price.  
Contact OTTO Direct for any special requirements.

- 4.) Freight terms: F.O.B. Factory, Carpentersville, IL
- 5.) Shipping policy: If product is in stock, orders will typically ship within 24 hours. All Domestic shipments are shipped UPS Surface and all International shipments are shipped UPS unless otherwise requested.
- 6.) Applicable taxes, shipping expenses, duties, and charges are in addition to prices shown.
- 7.) Customer purchase orders are subject to correction.
- 8.) Warranty: 15 months from the date of manufacture stamped on the product at OTTO's factory or date of invoice. See next page for detailed Warranty policy.
- 9.) We accept Visa and MasterCard.
- 10.) Return Policy — OTTO will accept returns on NEW product within 90 days of original purchase date with a 20% restocking fee. Individual restocking issues will be determined by OTTO.  
After 90 days, OTTO will not accept product returns.  
Please contact OTTO for a return authorization number before any product is shipped back.
- 11.) Prices and specifications subject to change without notice.
- 12.) OTTO Communication products are designed to produce a specific audio output level at maximum rated power. Modifying these devices in any way including adding or removing components and accessories may change the audio output of the device and could result in **PERMANENT HEARING DAMAGE.**

Many countries have regulations defining the amount of noise that an individual can be subjected to during a normal workday. The duration of exposure, the level of audio output and the level of ambient noise will affect compliance to these regulations. Compliance is application dependent and standards vary. It is the **SOLE RESPONSIBILITY** of the end user to determine applicability of and compliance to local hearing protection regulations.

In addition, if purchasing any OTTO accessories which use earphone kits, it is the **SOLE RESPONSIBILITY** of the user to determine proper fit. Always use caution when inserting any of the products into your ear.

## ePortal

---

OTTO offers Dealers access to up to date account and part number information through a new web link called ePortal.

Dealers can view:

**Part Numbers** — description, Dealer price, quantity available & lead times.

**Accounting Information** — account status, invoice numbers, open credit.

**RMA Information** — shows all open and closed RMA numbers with a link to detailed information.

**Order Information** — displays all open and closed sales orders with a link to detailed information.

### All information is available 24 hours a day, 7 days a week!!

Users simply log in using their individual email address and an OTTO assigned password.

Call Customer Service today 1-888-234-OTTO and request to sign up for an ePortal account!

## Warranty

---

OTTO makes the following warranty to purchasers of OTTO's products who buy direct from OTTO and from OTTO's authorized distributors. OTTO warrants that for a period of 15 months from the date of manufacture stamped on the product at OTTO's factory, its products will meet the nominal performance criteria stated in OTTO's printed publications and proposals and will be free from defects in material and workmanship. If a warranty claim is properly submitted, OTTO will inspect the OTTO product at OTTO's factory and will repair or replace, at OTTO's sole option, the product if defective. To properly submit a warranty claim the Purchaser must obtain OTTO's prior written authorization, must bear all costs of disassembly, and prepay all expenses of shipping the product to OTTO's factory, and must agree to pay all expenses for returning the product from OTTO's factory and reassembly. This warranty voided if any repair or replacement is made or attempted on any OTTO product by anyone other than authorized OTTO personnel at OTTO's factory without prior written consent, if the product has been altered by the customer, or if there has been any misuse or misapplication of the OTTO product, OTTO's only liability under its warranty is as stated above.

OTTO makes no warranty (1) to anyone who purchases or acquires any OTTO product from any source other than OTTO or its authorized distributors, (2) to anyone who purchases, acquires or uses any other manufacturer's product in which any OTTO product is a component, (3) or any other manufacturer's products as a component in any OTTO product. OTTO shall not be liable for any incidental or consequential damage caused by the nonconformance of any OTTO product with this warranty.

THERE ARE NO OTHER WARRANTIES, EXPRESSED OR IMPLIED, INCLUDING THOSE OF MERCHANTABILITY AND FITNESS FOR PARTICULAR PURPOSE.

(This warranty information is printed on the reverse side of OTTO's order acknowledgements)

## Return Procedure

---

To return product to OTTO Communications, please follow the steps below:

- a. Find the date code on the product, the invoice number, OR the date of purchase.  
(The date code can be found on the cable for headsets and low profile kits, on the back label for speaker mics)
- b. Call OTTO Communications Customer Service toll free at 888-234-6886 or email at [comsales@ottoeng.com](mailto:comsales@ottoeng.com) to obtain a return authorization number. Please indicate failure mode experienced (i.e. intermittent transmit or receive, low audio, failed push-to-talk, etc.)
- c. Indicate the RMA number on the outside of the box and any paperwork shipping with the product. International Returns must include the words "**U.S. Goods Returning. Not Dutiable**" in the paperwork and on label.
- d. Be sure to return the product within 90 days of receiving the RMA number. If not, call for a new authorization number.
- e. Ship the product to: OTTO Communications, 2 E. Main St., Carpentersville, IL 60110
- f. Allow 4 weeks **from receipt of product** for product to be returned.

### NOTES:

#### Dealer Pre-Testing of Equipment

We strongly recommend that all Dealers test customer product before returning to OTTO. If OTTO Quality Technicians are unable to duplicate or determine the stated failure mode, the product will be returned to the dealer.

#### Warranty vs. Non-Warranty

If the failure mode is determined to be a warranty issue (due to materials, workmanship or failure to meet printed specifications), the product will be replaced at no charge. If the failure mode is determined to be a non-warranty issue, the parts will be returned to the customer along with a Failure Analysis Report. At OTTO Communications' discretion, minor rework may be performed after contact is made with the customer to ensure an understanding of how the failure occurred.

#### Repair Service

OTTO Communications provides repair services for selected products. Contact customer service. Several replacement part options are available which will allow your technician to repair your unit, avoiding the purchase of a new unit.

## General Conditions of Sale

---

- 1.) Your order from OTTO is accepted at Carpentersville, Illinois at the indicated prices (with applicable taxes, if any being in addition) and subject to the condition that it is not in violation of any government rulings, conservation orders or other applicable laws and regulations. Changes in purchaser specifications from any submitted sample, drawing or OTTO specifications are subject to OTTO's acceptance in the same manner as the original order, and, in any event such changes are the responsibility of the Purchaser, and OTTO is to be reimbursed for all costs and materials which cannot be used due to the changed specifications unless written agreement to the contrary, signed by an officer of OTTO, expressly waives that responsibility. Prices shown for merchandise to be scheduled and shipped over a 12 month or longer period, are protected for the first 90 days from the effective date of any OTTO general price increase. Thereafter, the increase will be applied at the rate of 2% increase per month for the duration of the contract, but not to exceed the full amount of the increase. Any OTTO general price decreases made effective during the contract life will be applied to the balance of any scheduled order.
- 2.) Delivery promises are made in good faith, but are not guaranteed. OTTO will not be liable for any delay in delivery due to (a) fires, floods, strikes, or other labor disputes, accidents to machinery, acts of sabotage, riots, precedence or priorities granted at the request or for the benefit, directly or indirectly, of the Federal or any State Government or any subdivision or agency thereof, delays in transportation, or lack of transportation facilities, restrictions imposed by Federal or State legislation or rules or regulations thereunder, or (b) any other cause beyond the control of OTTO.
- 3.) Tools and dies embody OTTO's designs and any changes made to them represent only a portion of their costs. Accordingly, OTTO retains the title and all rights thereto including their possession. Engineering charges, if any, represent only a portion of the cost of all designs, drawings and inventions are and will remain proprietary to OTTO.
- 4.) On orders for any special merchandise, OTTO reserves the right to produce, ship and invoice quantities that may vary 5% more or less than the exact quantity specified on the order.
- 5.) The order is a firm commitment on the part of the Purchaser. If it is necessary for the Purchaser to cancel all or part of the undelivered balance, OTTO shall invoice and the Purchaser shall be obligated to pay for any partially complete units, special materials which have been purchased for the contract, fully completed unshipped units for special materials ordered, fully completed unshipped units containing special parts or materials, OTTO's overhead expenses and other expenses incurred in exercising cancellation, and for any price difference in quantity taken vs. quantity ordered. Purchaser agrees to pay such charges within 30 days after cancellation.
- 6.) Merchandise returned for credit without prior approval of OTTO will be either credited at OTTO's valuation or rejected, at OTTO's option.
- 7.) LIMITED WARRANTY — OTTO makes the following limited warranty to purchasers of OTTO's products who buy direct from OTTO and from OTTO's authorized distributors. OTTO warrants that for a period of fifteen months from the date of manufacture stamped on product at OTTO's factory, its products will meet the nominal performance criteria stated in OTTO's printed publications and proposals and will be free from defects in material and workmanship. If a warranty claim is properly submitted, OTTO will inspect the OTTO product at OTTO's factory and if the product is defective, OTTO, at its option, will either repair or replace the defective product or refund the purchase price paid by the Purchaser for the defective product. To properly submit a warranty claim the Purchaser must obtain OTTO's prior written authorization to return the product(s), must bear all costs of disassembly, and prepay all expenses of shipping the product to OTTO's factory, and must agree to pay all expenses for returning the product from OTTO's factory and reassembly. This warranty will be voided if any repair, replacement or alteration is made or attempted on any OTTO product by anyone other than authorized OTTO personnel at OTTO's factory without OTTO's prior written consent, or if there has been any misuse or misapplication of the OTTO product. OTTO's only liability under its warranty is as stated above. OTTO makes no warranty (1) to anyone who purchases or acquires any OTTO product from any source other than OTTO or its authorized distributors, (2) to anyone who purchases, acquires or uses any other manufacturer's product in which any OTTO product is a component, or (3) with regard to any other manufacturer's product used as a component in any OTTO product. OTTO shall not be liable for any incidental or consequential damage caused by the nonconformance of any OTTO product with this warranty. THERE ARE NO OTHER WARRANTIES, EXPRESSED OR IMPLIED, INCLUDING THOSE OF MERCHANTABILITY AND FITNESS FOR PARTICULAR PURPOSE.
- 8.) All contracts involving merchandise by OTTO shall not grant the Purchaser any license or right of any kind under any patent, trademark, trade name or copyright owned or controlled by OTTO or under which OTTO has a license, except as may be specifically granted in writing signed by an officer of OTTO or which flow as a matter of law from the sale per se.
- 9.) All contracts of Purchaser involving the later sale or use of merchandise of OTTO as a component in any process or combination with other components, or special use, will hold OTTO harmless against infringement of any letters patent, copyrights, trademarks, trade secrets, or trade names which may arise through such application or use of OTTO merchandise and Purchaser agrees to indemnify, defend and save OTTO harmless from all cost and expense, including attorney's fees, arising from such application and use by Purchaser or third party.
- 10.) Where products are manufactured by OTTO to meet Purchaser's particular specifications or requirements and not part of OTTO's standard line offered by it to the trade generally in the usual course of business, Purchaser agrees to defend, indemnify and save harmless OTTO against all suits at law or in equity and from all damage, claims and demands for actual or alleged infringement of any United States or foreign patent because of the manufacture and/or sale of the product covered hereby.
- 11.) OTTO reserves the right, among other remedies, to terminate or suspend further deliveries in the event Purchaser fails to pay for any one shipment when the same has become due. Should Purchaser's financial responsibility become unsatisfactory to OTTO, cash payments or other satisfactory security may be required by OTTO for future delivery and for goods theretofore delivered. If necessary, Purchaser shall sign any document necessary to protect OTTO's interest in the goods while any part of purchase price remains unpaid.
- 12.) Unless specifically stated otherwise, all sales are f.o.b. Carpentersville, Illinois and Purchaser shall assume all responsibility and risk of loss in connection with goods upon delivery thereof to a common carrier.

- 13.) Unless otherwise provided herein, OTTO warrants good title and that the goods shall be free from all liens, security interest, or other encumbrances. In the event that goods are reclaimed by a third party as rightful owner, or there exists a lien, security interest, or other encumbrance on the goods, Purchaser's remedy shall be limited to the right to restitution of the purchase price.
- 14.) In the absence of a written acceptance of these terms and conditions of sale by the Purchaser, acceptance of any of the goods by Purchaser shall constitute acceptance of these terms and conditions notwithstanding any contrary or inconsistent oral communications. OTTO's failure to object to any contrary or inconsistent provisions contained in any request for proposal, purchase order or other written communication from Purchaser shall not be deemed a waiver or modification of these terms and conditions of sale, or acceptance by OTTO of any such contrary or inconsistent provisions. Any deviation from these terms and conditions of sale shall not be binding on OTTO unless they are reduced to writing and signed by an officer of OTTO.
- 15.) Stenographic and clerical errors are subject to correction.
- 16.) Any acts construable as a waiver of any terms or conditions of sale shall be deemed as noncontinuing in nature and not deemed a waiver of future application of the terms and conditions.
- 17.) Any claims for shortage or any claim for credit from OTTO for any cause must be submitted to OTTO within 30 days after delivery or such claim shall be deemed waived. The merchandise delivered hereunder is subject to the Purchaser's inspection within 30 days after delivery to Purchaser or its agent and OTTO agrees to either repair, replace, or issue credit for, at OTTO's sole option, all defective merchandise that has not been altered.
- 18.) OTTO warrants that it has complied with all of the provisions of the Fair Labor Standards Act of 1938 of the United States.
- 19.) There are incorporated herein the provisions of Executive Order 11246 (as amended) of the President of the United States on Equal Employment Opportunity and the Rules and Regulations issued pursuant thereto with which OTTO represents that it will comply, unless exempted.
- 20.) Purchaser may not assign its rights or delegate its performance without the written consent of OTTO, and any attempted assignment or delegation without such consent shall be void.
- 21.) These terms and conditions of sale shall be considered severable and failure or voiding of any one term or condition shall not affect any other terms or conditions. These terms and conditions shall be construed under and governed by the laws of the State of Illinois.

**SURVEILLANCE KITS**



Earphone kits w/radio interface



Two wire palm mic kit



Three wire mini lapel mic kit

**Ear Receiver  
(Squelched or Standard)**



Flat Pack



Neck Loop



Two wire earbud  
with mic/ptt

Flexible Open  
Ear Insert



Ear insert options for acoustic tube kits



Noise Attenuating  
Plugs

**Wireless Accessory Options**

**LIGHTWEIGHT HEADSETS**



Explorer



Lightweight



Breeze



Remote PTT Option-80MM Body PTT



Breeze with Adjustable Headband



Hurricane



Remote PTT  
Option-Ring PTT



2.5 mm Pigtail  
for Remote PTT options

**HEAVY DUTY HEADSETS**



Over-the-head style



Behind-the-head style



Hurricane



Ranger

(ClearTRAK versions are shipped with an extreme noise canceling microphone element (approx. 19dB vs. 3dB on std. Heavy duty hdat.)



SPEAKER MICROPHONES



Legacy



Profile



Evolution & Evolution H<sub>2</sub>O



Lightsword



Genesis



XTS Series  
Evolution  
Antenna  
Option



Earphone kit for use with Evolution,  
Profile & Legacy speaker microphones

TACTICAL, FIRE & HAZMAT (Also see Evolution and Genesis speaker microphones)



Skull Mic System



Skull Mic Only



Throat Microphone System

ACCESSORY ADAPTERS

Adapter for  
Kenwood TR480  
Series allowing  
Use of Receive  
only Kits  
VI-10430



Adapter for  
Motorola  
HT1000  
Series Radios  
VI-10335



Adapter for  
Motorola Saber Radio Series allowing  
Use of Accessories with a 12 pin  
Hirose connector  
VI-10581



Adapter for  
Motorola HT1000 Radio Series  
allowing  
Use of Accessories with a 12 pin  
Hirose connector  
VI-10527



## OTTO Communications Connector Styles



12 Pin Hirose Connector



2.5mm vs 3.5mm Plug Comparison

E.F. Johnson 5100  
(With adapter V1-10335)

E.F. Johnson 7780/8100 Series

ICOM F30G-F40G Molded Connector  
ICOM 50-60 (wiring different)

ICOM F3-F4 2.5mm-3.5 Plug



ICOM F3G, F4G 2.5mm-3.5mm Plug



ICOM F33/F43



Kenwood TK250 2.5mm-3.5mm Plug



Kenwood TK480 Assembled Connector

M/A-COM EDACS 300P  
Assembled ConnectorM/A-COM Jaguar 700P  
Assembled ConnectorM/A-COM KPC-Panther 500P  
Assembled ConnectorM/A-COM MPA-MPD  
Assembled ConnectorM/A-COM Panther 300P  
2.5mm-3.5mm PlugM/A-COM PCS  
Assembled ConnectorM/A-COM MRK  
Assembled ConnectorM/A-COM Prism LPE  
Assembled Connector

Maxon 6 Pin Hirose Connector



Maxon SP200 Single Pin



MaxonSP/Midland 80 Series



Motorola GP300 2.5mm-3.5mm Plug



Motorola EX500



Motorola HT1000 3.5mm Threaded Plug

**OTTO Communications Connector Styles**



Motorola HT1000 Adapter (V1-10335)  
(Only used with 3.5mm Accessories)



Motorola HT1000  
Assembled Connector



Motorola HT750 Assembled Connector



Motorola Saber  
Assembled Side Connector



Motorola SP10, SP21  
2.5mm-3.5mm Plug



Motorola Spirit GT-GT+FP9 2.5mm Plug



Motorola Visar



Motorola XTS3000 Antenna  
Assembled Connector



Thales (Used with adapter 85305)



Reim Wireless GPH, DPH



Reim Wireless RPU416, RPU516



Reim Wireless RP3000, RP3600



Tait Orca  
(Use with adapter TOPA-AA-005)



Vertex VX10, VX300  
Single Pin Connector



Vertex VX-210, VX400



Vertex VX500 2.5mm-3.5mm Plug



Vertex VX800 Assembled Connector  
Vertex VX537 (Different Wiring)

**E.F. Johnson  
5000 (Stealth), 5100**

3.5mm Threaded plug (Requires adapter)

Assembled connector (No adapter required)



Adapter V1-10335



PART NUMBER	DESCRIPTION	SUGGESTED RESALE
-------------	-------------	---------------------

**SURVEILLANCE KITS** *Requires Adapter V1-10335*

V1-10174	1 Wire Earphone Kit <b>Black (Receive only no transmit)</b>	\$ 42.30
V1-10173	1 Wire Earphone Kit <b>Beige (Receive only no transmit)</b>	\$ 42.30
V1-B22MA131	2 Wire Earbud <b>Black</b>	\$ 48.43
V1-10172	2 Wire Palm Microphone Kit <b>Black</b>	\$ 119.85
V1-10171	2 Wire Palm Microphone Kit <b>Beige</b>	\$ 119.85
V1-10337	2 Wire Field <b>Repairable</b> Palm Microphone Kit <b>Black</b>	\$ 156.07
V1-10170	3 Wire Mini Lapel Microphone Kit <b>Black</b>	\$ 136.54
V1-10169	3 Wire Mini Lapel Microphone Kit <b>Beige</b>	\$ 136.54
V1-10335	Adapter required with use of above Surveillance Kits	\$ 51.25

**EAR INSERT OPTION** *Consult table of contents for additional Ear Insert Options*

C800947	Regular Clear Ear Tip	\$ 1.06
C100733	Noise Attenuating Plugs ( <b>NRR 25dB</b> )	\$ 2.33
C806573-LM	Flexible Open Ear Inserts Left, Medium	\$ 15.38
C806573-RM	Flexible Open Ear Inserts Right, Medium	\$ 15.38

**WIRELESS ACCESSORIES FOR USE WITH SURVEILLANCE KITS**

V1-10610	Wireless Ear Receiver used with Flat Pack Inductor or Neckloop (Conventional Version)	\$ 202.44
V1-10611	Wireless Ear Receiver used with Flat Pack Inductor or Neckloop (Squelched Version)	\$ 260.86
V1-10471	Flat Pack Inductor with 2 prong jack for use with existing 2 & 3 Wire Kits	\$ 70.73
V1-10666	28" Universal neck loop	\$ 70.73
V1-10603	49" Universal neck loop	\$ 80.98
C819021	Replacement batteries (4) for Wireless Ear Receiver	\$ 11.26
C101114	Wax Trap (15) and Installation Tool (Replacement Part for Wireless Ear Receiver)	\$ 18.96

**HEADSETS** *Requires Adapter V1-10335*

V4-EX2MA5	Explorer, lightweight, flexible earloop, w/ boom mic, quick-disconnect acoustic tube, mini PTT	\$ 93.15
V4-BA2MA1	Breeze, lightweight, behind-the-head, single spkr with standard PTT	\$ 77.66
* V4-BA2MA3B	Breeze, lightweight, behind-the-head, single spkr w/std. PTT & 2.5mm pigtail for remote PTT	\$ 86.06
V4-10191	Lightweight Single Speaker Padded Headband no PTT	\$ 72.17
V4-10050	Lightweight Single Speaker Padded Headband with standard PTT	\$ 113.85
V4-HC2MA5	Hurricane, lightweight, dual spkr, 21dB reduction, behind-the-head, with mini PTT	\$ 239.98
* V4-HC2MA3B	Hurricane, lightweight, dual spkr, 21dB reduction, behind-the-head, w/std. PTT & 2.5mm pigtail for remote PTT	\$ 249.17
V4-HE2MA5	Hurricane, lightweight, dual spkr, 21dB reduction, behind-the-head, with mini PTT & Extreme Noise Microphone	\$ 259.98
V4-NR2MA1	Ranger Single Speaker behind-the-head with standard PTT	\$ 306.48
* V4-NR2MA3B	Ranger Single Speaker behind-the-head w/std. PTT & 2.5mm pigtail for remote PTT	\$ 326.98
V4-10145	Over-the-head Dual Speaker Heavy Duty with standard PTT	\$ 265.40
V4-10002	Behind-the-Head Dual Speaker Heavy Duty with standard PTT	\$ 306.48
V4-10024	ClearTRAK Behind-the-Head Dual Speaker Extreme Noise with Earcup PTT	\$ 385.32
V4-10364	ClearTRAK Over-the-Head Dual Speaker Extreme Noise with Earcup PTT	\$ 344.25
V1-10335	Adapter required with use of above Headsets	\$ 50.00

**\* REMOTE PTT ACCESSORIES FOR BREEZE AND HURRICANE HEADSETS WITH 2.5MM JACK**

V1-10513	Ring PTT with 2.5mm right angle plug, 5' straight cable	\$ 25.63
V1-10519	80mm Round Body PTT with 2.5mm right angle plug, coil cord	\$ 96.77

**CONSULT TABLE OF CONTENTS FOR REPLACEMENT PARTS & ADDITIONAL EAR INSERT OPTIONS**

**CONTACT FACTORY FOR ALL INTRINSICALLY SAFE APPROVED PRODUCTS**

**E.F. Johnson  
5000 (Stealth), 5100**

**E.F. JOHNSON**

PART NUMBER	DESCRIPTION	SUGGESTED RESALE
-------------	-------------	---------------------

<b>SPEAKER MICROPHONES</b> <i>No Adapter Required</i>		
V2-L2MA11	Profile Speaker Microphone with 2.5mm earphone jack	\$ 91.38
V2-10031	Evolution Speaker Mic with Coil cord, volume control and 2.5mm earphone jack	\$ 102.49
V2-10074	Evolution Speaker Mic with Coil cord, Hi for Hi background noise/Lo for low background noise, 2.5mm earphone jack	\$ 102.49
V2-10173	Evolution Speaker Mic with Coil cord, volume control, 2.5mm earphone jack and emergency button	\$ 117.39
V2-10023	Evolution Speaker Mic with Straight Coaxial cord, volume control, 2.5mm earphone jack and antenna connector <b>(5000 only)</b>	\$ 113.73
V2-10139	Evolution Speaker Mic with Coiled Coaxial cord, volume control, 2.5mm earphone jack and antenna connector <b>(5000 only)</b>	\$ 120.85
V2-10202	Evolution Speaker Mic with Coiled Coaxial cord, volume control, 2.5mm earphone jack, antenna connector and emergency button	\$ 139.38
V2-10276	Evolution Speaker Mic with Coaxial Connector, Coiled Coaxial cord, volume control, antenna connector and 2.5mm earphone jack <b>(5100 only)</b>	\$ 254.51
V2-10178	Evolution H20 Immersion Rated (IP68), with Coil Cord, volume control	\$ 121.99
V2-10179	Evolution H20 Immersion Rated (IP68) with Straight Coaxial cord, volume control, and antenna connector <b>(5000 only)</b>	\$ 134.23
V2-10180	Evolution H20 Immersion Rated (IP68) with Coiled Coaxial cord, volume control, and antenna connector <b>(5000 only)</b>	\$ 140.35
V2-10269	Evolution H20 Immersion Rated (IP68) with Coaxial Connector, Coiled Coaxial cord, volume control and antenna connector <b>(5100 only)</b>	\$ 255.50
V2-D2MA111	Lightsword Speaker with LED, on/off control, coil cord and 2.5mm earphone jack	\$ 180.00
V2-G2MA211	Genesis with Coil Cord	\$ 143.55
V2-G2MA221	Genesis Coil Cord and Emergency Button	\$ 139.98
V2-G2MA213	Genesis Straight Coax Cable and Antenna Connector <b>(5000 only)</b>	\$ 144.98
V2-G2MA223	Genesis Straight Coax Cable, Antenna Connector & Emergency Button <b>(5000 only)</b>	\$ 146.92
V2-G2MA212	Genesis Coiled Coax Cable and Antenna Connector <b>(5000 only)</b>	\$ 170.00
V2-G2MA222	Genesis Coiled Coax Cable, Antenna Connector & Emergency Button <b>(5000 only)</b>	\$ 144.02
V2-G2MA311	Genesis with Coil Cord & Accessory Jack	\$ 158.57
V2-G2MA321	Genesis Coil Cord, Emergency Button & Accessory Jack	\$ 154.98
V2-G2MA313	Genesis Straight Coax Cable, Antenna Connector & Accessory Jack <b>(5000 only)</b>	\$ 159.98
V2-G2MA323	Genesis Straight Coax Cable, Antenna Connector, Emergency Button & Accessory Jack <b>(5000 only)</b>	\$ 161.92
V2-G2MA312	Genesis Coiled Coax Cable, Antenna Connector & Accessory Jack <b>(5000 only)</b>	\$ 185.00
V2-G2MA322	Genesis Coiled Coax Cable, Antenna Connector, Emergency Button & Accessory Jack <b>(5000 only)</b>	\$ 254.50
V2-G2JX212	Genesis Coaxial Connector, Coiled Coax Cable and Antenna Connector <b>(5100 only)</b>	\$ 254.50
V2-G2JX312	Genesis Coaxial Connector, Coiled Coax Cable, Antenna Connector and Accessory Jack <b>(5100 only)</b>	\$ 285.00

<b>EARPHONE KITS FOR USE WITH EVOLUTION, LIGHTSWORD AND PROFILE SPEAKER MICROPHONES ONLY</b>		
V1-10282	2.5mm straight plug, coil cord (30" extended length), black	\$ 47.44
V1-10432	2.5mm right angle plug, coil cord (30" extended length), black	\$ 47.44
V1-EH22R131	2.5mm right angle plug, <b>Earhanger</b> , coil cord (30" extended length), black	\$ 26.93
V1-10305	3.5mm straight plug, coil cord (30" extended length), black	\$ 47.44
V1-10433	3.5mm right angle plug, coil cord (30" extended length) black	\$ 47.44

<b>ACCESSORIES FOR GENESIS WITH ACCESSORY JACK OPTION</b>		
V1-10750	Earphone with acoustic tube and Hirose Connector	\$ 91.78
V4-10478	Hurricane, lightweight, dual sprk, 21db reduction, behind-the-head with Hirose Connector	\$ 265.38
V1-10656	Throat Microphone with Hirose Connector	\$ 289.58
V4-10421	Ranger Single Speaker, behind-the-head, NO PTT with Hirose Connector	\$ 291.84
V4-10450	Behind-the-head Dual Speaker Heavy Duty with no PTT	\$ 306.24
V4-10428	Skull Microphone with Hirose Connector	\$ 310.81
V3-10301	SCBA-ISI Hirose Connector Interface Cable	\$ 115.38

<b>TACTICAL, FIRE, &amp; HAZMAT COMMUNICATIONS EQUIPMENT</b> <i>No Adapter Required</i>		
V1-T12MA137	Throat Microphone with Acoustic Tube & 80 MM PTT	\$ 470.48
V1-T12MA117	Throat Microphone with Acoustic Tube and Remote Ring PTT	\$ 526.85
V4-10231	Skull Microphone with Earcup & 80 MM PTT	\$ 562.73

*See also Evolution and Genesis Speaker Microphone options above*

**CONSULT TABLE OF CONTENTS FOR REPLACEMENT PARTS & ADDITIONAL EAR INSERT OPTIONS**  
**CONTACT FACTORY FOR ALL INTRINSICALLY SAFE APPROVED PRODUCTS**

# Icom

F3, F3S, F4, F4S, F4TR, F10, F20, IC-H2, H6, J12, M5, U12, U16

2.5/3.5 Straight Connector



PART NUMBER	DESCRIPTION	SUGGESTED RESALE
-------------	-------------	------------------

## SURVEILLANCE KITS

V1-10252	1 Wire Earphone Kit <b>Black (Receive only no transmit)</b>	\$ 46.56
V1-10246	1 Wire Earphone Kit <b>Beige (Receive only to transmit)</b>	\$ 46.56
V1-B22CA131	2 Wire Earbud <b>Black</b>	\$ 48.43
V1-10395	2 Wire Palm Microphone Kit <b>Black</b>	\$ 87.89
V1-10586	2 Wire Palm Microphone Kit <b>Beige</b>	\$ 87.89
V1-10396	3 Wire Mini Lapel Microphone Kit <b>Black</b>	\$ 152.75
V1-10587	3 Wire Mini Lapel Microphone Kit <b>Beige</b>	\$ 152.75

## EAR INSERT OPTIONS

*Consult table of contents for additional Ear Insert Options*

C800947	Regular Clear Ear Tip	\$ 1.06
C100733	Noise Attenuating Plugs ( <b>NRR 25dB</b> )	\$ 2.33
C806573-LM	Flexible Open Ear Inserts Left, Medium	\$ 15.38
C806573-RM	Flexible Open Ear Inserts Right, Medium	\$ 15.38

## WIRELESS ACCESSORIES FOR USE WITH SURVEILLANCE KITS

V1-10610	Wireless Ear Receiver used with Flat Pack Inductor (Conventional Version)	\$ 202.44
V1-10611	Wireless Ear Receiver used with Flat Pack Inductor (Squelched Version)	\$ 260.86
V1-10471	Flat Pack Inductor with 2 prong jack for use with existing 2 & 3 Wire Kits	\$ 70.73
V1-10666	28" Universal neck loop	\$ 70.73
V1-10603	49" Universal neck loop	\$ 80.98
C819021	Replacement batteries (4) for Wireless Ear Receiver	\$ 11.26
C101114	Wax Trap (15) and Installation Tool (Replacement Part for Wireless Ear Receiver)	\$ 18.96

## HEADSETS

V4-EX2CA5	Explorer, lightweight, flexible earloop, w/ boom mic, quick-disconnect acoustic tube, mini PTT	\$ 87.88
V4-BA2CA1	Breeze, lightweight, behind-the-head, single spkr with standard PTT	\$ 77.66
V4-10120	Lightweight Single Speaker Padded Headband with standard PTT	\$ 102.15
V4-10121	Over-the-head Dual Speaker Heavy Duty with standard PTT	\$ 282.87
V4-10122	Behind-the-Head Dual Speaker Heavy Duty with standard PTT	\$ 331.76

## SPEAKER MICROPHONES

V2-L2CA11	Profile Speaker Microphone with 2.5mm earphone jack	\$ 66.23
V2-10083	Evolution Speaker Mic with Coil cord, volume control and 2.5mm earphone jack	\$ 89.18

## EARPHONE KITS FOR USE WITH EVOLUTION AND PROFILE REMOTE SPEAKER MICROPHONES ONLY

V1-10282	2.5mm straight plug, coil cord (30" extended length), black	\$ 47.44
V1-10432	2.5mm right angle plug, coil cord (30" extended length), black	\$ 47.44
V1-EH22R131	2.5mm right angle plug, <b>Earhanger</b> , coil cord (30" extended length), black	\$ 26.93
V1-10305	3.5mm straight plug, coil cord (30" extended length), black	\$ 47.44
V1-10433	3.5mm right angle plug, coil cord (30" extended length) black	\$ 47.44

**CONSULT TABLE OF CONTENTS FOR REPLACEMENT PARTS & ADDITIONAL EAR INSERT OPTIONS**

**CONTACT FACTORY FOR ALL INTRINSICALLY SAFE APPROVED PRODUCTS**

# Icom

## F3G, F3GS, F4G, F4GS

2.5/3.5 Right Angle Connector



PART NUMBER	DESCRIPTION	SUGGESTED RESALE
-------------	-------------	---------------------

### SURVEILLANCE KITS

V1-10436	1 Wire Earphone Kit, w/single 3.5mm right angle plug, <b>Black (Receive only no transmit)</b>	\$ 46.57
V1-B22CC131	2 Wire Earbud <b>Black</b>	\$ 48.43
V1-10599	2 Wire Palm Microphone Kit <b>Black</b>	\$ 87.89
V1-10600	3 Wire Mini Lapel Microphone Kit <b>Black</b>	\$ 152.73

### EAR INSERT OPTIONS Consult table of contents for additional Ear Insert Options

C800947	Regular Clear Ear Tip	\$ 1.06
C100733	Noise Attenuating Plugs ( <b>NRR 25dB</b> )	\$ 2.33
C806573-LM	Flexible Open Ear Inserts Left, Medium	\$ 15.38
C806573-RM	Flexible Open Ear Inserts Right, Medium	\$ 15.38

### WIRELESS ACCESSORIES FOR USE WITH SURVEILLANCE KITS

V1-10610	Wireless Ear Receiver used with Flat Pack Inductor or Neckloop (Conventional Version)	\$ 202.44
V1-10611	Wireless Ear Receiver used with Flat Pack Inductor or Neckloop (Squelched Version)	\$ 260.86
V1-10471	Flat Pack Inductor with 2 prong jack for use with existing 2 & 3 Wire Kits	\$ 70.73
V1-10666	28" Universal neck loop	\$ 70.73
V1-10603	49" Universal neck loop	\$ 80.98
C819021	Replacement batteries (4) for Wireless Ear Receiver	\$ 11.26
C101114	Wax Trap (15) and Installation Tool (Replacement Part for Wireless Ear Receiver)	\$ 18.96

### HEADSETS

V4-EX2CC5	Explorer, lightweight, flexible earloop, w/ boom mic, quick-disconnect acoustic tube, mini PTT	\$ 87.88
V4-BA2CC5	Breeze, lightweight, behind-the-head, single spkr with mini PTT	\$ 47.15
V4-BA2CC1	Breeze, lightweight, behind-the-head, single spkr with standard PTT	\$ 77.66
V4-BA2CC3B	Breeze, lightweight, behind-the-head, single spkr w/std. PTT & 2.5mm pigtail for remote PTT	\$ 86.06
V4-10393	Lightweight Single Speaker Padded Headband with standard PTT	\$ 102.15
V4-HC2CC5	Hurricane, lightweight, dual spkr, 21dB reduction, behind-the-head, with mini PTT	\$ 224.98
V4-NR2CC1	Ranger Single Speaker behind-the-head with standard PTT	\$ 306.48
V4-10394	Over-the-head Dual Speaker Heavy Duty with standard PTT	\$ 282.87
V4-10395	Behind-the-head Dual Speaker Heavy Duty with standard PTT	\$ 331.76

### SPEAKER MICROPHONES

V2-C2CC11	Legacy Speaker Microphone with 2.5mm earphone jack	\$ 37.44
V2-L2CC11	Profile Speaker Microphone with 2.5mm earphone jack	\$ 66.24
V2-10200	Evolution Speaker Mic with Coil cord, volume control and 2.5mm earphone jack	\$ 89.18
V2-10253	Evolution H20 Immersion Rated (IP68), with Coil Cord, volume control	\$ 108.81

### EARPHONE KITS FOR USE WITH EVOLUTION AND PROFILE REMOTE SPEAKER MICROPHONES ONLY

V1-10282	2.5mm straight plug, coil cord (30" extended length), black	\$ 47.44
V1-10432	2.5mm right angle plug, coil cord (30" extended length), black	\$ 47.44
V1-EH22R131	2.5mm right angle plug, <b>Earhanger</b> , coil cord (30" extended length), black	\$ 26.93
V1-10305	3.5mm straight plug, coil cord (30" extended length), black	\$ 47.44
V1-10433	3.5mm right angle plug, coil cord (30" extended length) black	\$ 47.44

### EARPHONE KIT FOR USE WITH LEGACY SPEAKER MICROPHONE ONLY

V1-10598	2.5mm straight plug Coil Cord (12" length), black	\$ 29.95
----------	---	----------

**CONSULT TABLE OF CONTENTS FOR REPLACEMENT PARTS & ADDITIONAL EAR INSERT OPTIONS**

**CONTACT FACTORY FOR ALL INTRINSICALLY SAFE APPROVED PRODUCTS**

ICOM

**Icom**  
**F11, F11S, F14, F21, F21S, F24, F33GS, F33GT, F43GS, F43GT, F43TR**

2.5/3.5 Right Angle Overmolded Connector with 2 Screws



PART NUMBER	DESCRIPTION	SUGGESTED RESALE
-------------	-------------	---------------------

**SURVEILLANCE KITS**

V1-10755	1 Wire Earphone Kit, w/single 3.5mm right angle plug, <b>Black (Receive only no transmit)</b>	\$ 49.50
V1-10756	2 Wire Palm Microphone Kit <b>Black</b>	\$ 91.84
V1-10757	3 Wire Mini Lapel Microphone Kit <b>Black</b>	\$ 162.96

**EAR INSERT OPTIONS** *Consult table of contents for additional Ear Insert Options*

C800947	Regular Clear Ear Tip	\$ 1.06
C100733	Noise Attenuating Plugs ( <b>NRR 25dB</b> )	\$ 2.33
C806573-LM	Flexible Open Ear Inserts Left, Medium	\$ 15.38
C806573-RM	Flexible Open Ear Inserts Right, Medium	\$ 15.38

**WIRELESS ACCESSORIES FOR USE WITH SURVEILLANCE KITS**

V1-10610	Wireless Ear Receiver used with Flat Pack Inductor or Neckloop (Conventional Version)	\$ 202.44
V1-10611	Wireless Ear Receiver used with Flat Pack Inductor or Neckloop (Squelched Version)	\$ 260.86
V1-10471	Flat Pack Inductor with 2 prong jack for use with existing 2 & 3 Wire Kits	\$ 70.73
V1-10666	28" Universal neck loop	\$ 70.73
V1-10603	49" Universal neck loop	\$ 80.98
C819021	Replacement batteries (4) for Wireless Ear Receiver	\$ 11.26
C101114	Wax Trap (15) and Installation Tool (Replacement Part for Wireless Ear Receiver)	\$ 18.96

**HEADSETS**

V4-EX2CS5	Explorer, lightweight, flexible earloop, w/ boom mic, quick-disconnect acoustic tube, mini PTT	\$ 93.00
V4-BA2CS5	Breeze, lightweight, behind-the-head, single spkr with mini PTT	\$ 53.50
V4-BA2CS1	Breeze, lightweight, behind-the-head, single spkr with standard PTT	\$ 83.40
V4-10479	Lightweight Single Speaker Padded Headband with standard PTT	\$ 105.82
V4-HC2CS3B	Hurricane, lightweight, dual spkr, 21dB reduction, behind-the-head, w/std. PTT & 2.5mm pigtail for remote PTT	\$ 239.98
V4-NR2CS1	Ranger Single Speaker behind-the-head with standard PTT	\$ 315.00
V4-10480	Over-the-head Dual Speaker Heavy Duty with standard PTT	\$ 278.63
V4-10481	Behind-the-head Dual Speaker Heavy Duty with standard PTT	\$ 325.13

**\* REMOTE PTT ACCESSORIES FOR HURRICANE HEADSET WITH 2.5MM JACK**

V1-10513	Ring PTT with 2.5mm right angle plug, 5' straight cable	\$ 25.63
V1-10519	80mm Round Body PTT with 2.5mm right angle plug, coil cord	\$ 96.77

**SPEAKER MICROPHONES**

V2-C2CS11	Legacy Speaker Microphone with 2.5mm earphone jack	\$ 37.44
V2-L2CS11	Profile Speaker Microphone with 2.5mm earphone jack	\$ 68.85
V2-10288	Evolution Speaker Mic with Coil cord, volume control and 2.5mm earphone jack	\$ 94.69
V2-10290	Evolution H20 Immersion Rated (IP68), with Coil Cord, volume control	\$ 115.19
V2-G2CS211	Genesis with Coil Cord	\$ 158.57

**EARPHONE KITS FOR USE WITH EVOLUTION AND PROFILE REMOTE SPEAKER MICROPHONES ONLY**

V1-10282	2.5mm straight plug, coil cord (30" extended length), black	\$ 47.44
V1-10432	2.5mm right angle plug, coil cord (30" extended length), black	\$ 47.44
V1-EH22R131	2.5mm right angle plug, <b>Earhanger</b> , coil cord (30" extended length), black	\$ 26.93
V1-10305	3.5mm straight plug, coil cord (30" extended length), black	\$ 47.44
V1-10433	3.5mm right angle plug, coil cord (30" extended length) black	\$ 47.44

**EARPHONE KIT FOR USE WITH LEGACY SPEAKER MICROPHONE ONLY**

V1-10598	2.5mm straight plug Coil Cord (12" length), black	\$ 29.95
----------	---	----------

**TACTICAL, FIRE, & HAZMAT COMMUNICATIONS EQUIPMENT**

V1-T12CS137	Throat Microphone with Acoustic Tube & 80 MM PTT	\$ 445.00
-------------	--	-----------

**CONSULT TABLE OF CONTENTS FOR REPLACEMENT PARTS & ADDITIONAL EAR INSERT OPTIONS**

**CONTACT FACTORY FOR ALL INTRINSICALLY SAFE APPROVED PRODUCTS**

ICOM



**Icom**  
**F30G, F40G, F31GS, GT, M88, M87**

Multi Pin Connector



PART NUMBER	DESCRIPTION	SUGGESTED RESALE
<b>SURVEILLANCE KITS</b>		
V1-10601	2 Wire Palm Microphone Kit <b>Black</b>	\$ 91.84
V1-10602	3 Wire Mini Lapel Microphone Kit <b>Black</b>	\$ 162.96
<b>EAR INSERT OPTIONS</b> <i>Consult table of contents for additional Ear Insert Options</i>		
C800947	Regular Clear Ear Tip	\$ 1.06
C100733	Noise Attenuating Plugs ( <b>NRR 25dB</b> )	\$ 2.33
C806573-LM	Flexible Open Ear Inserts Left, Medium	\$ 15.38
C806573-RM	Flexible Open Ear Inserts Right, Medium	\$ 15.38
<b>WIRELESS ACCESSORIES FOR USE WITH SURVEILLANCE KITS</b>		
V1-10610	Wireless Ear Receiver used with Flat Pack Inductor or Neckloop (Conventional Version)	\$ 202.44
V1-10611	Wireless Ear Receiver used with Flat Pack Inductor or Neckloop (Squelched Version)	\$ 260.86
V1-10471	Flat Pack Inductor with 2 prong jack for use with existing 2 & 3 Wire Kits	\$ 70.73
V1-10666	28" Universal neck loop	\$ 70.73
V1-10603	49" Universal neck loop	\$ 80.98
C819021	Replacement batteries (4) for Wireless Ear Receiver	\$ 11.26
C101114	Wax Trap (15) and Installation Tool (Replacement Part for Wireless Ear Receiver)	\$ 18.96
<b>HEADSETS</b>		
V4-BA2CD1	Breeze, lightweight, behind-the-head, single spkr with standard PTT	\$ 83.38
V4-10397	Lightweight Single Speaker Padded Headband with standard PTT	\$ 105.82
V4-HC2CD1	Hurricane, lightweight, dual spkr, 21dB reduction, behind-the-head, with Std. PTT	\$ 239.98
V4-HC2CD3B	Hurricane with Extreme Noise Canceling mic, lightweight, dual spkr, 21dB reduction, behind-the-head, w/ Std. PTT & 2.5mm pigtail for remote PTT	\$ 259.98
V4-NR2CD1	Ranger Single Speaker behind-the-head with standard PTT	\$ 315.00
V4-10391	Over-the-head Dual Speaker Heavy Duty with standard PTT	\$ 278.63
V4-10392	Behind-the-Head Dual Speaker Heavy Duty with standard PTT	\$ 325.13
<b>SPEAKER MICROPHONES</b>		
V2-L2CD11	Profile Speaker Microphone with 2.5mm earphone jack	\$ 68.85
V2-10162	Evolution Speaker Mic with Coil cord, volume control and 2.5mm earphone jack	\$ 94.69
V2-10279	Evolution Speaker Mic with Coil cord, volume control, emergency button and 2.5mm earphone jack	\$ 109.44
V2-10234	Evolution H20 Immersion Rated (IP68), with Coil Cord, volume control	\$ 115.18
V2-G2CD211	Genesis with Coil Cord	\$ 158.57
V2-G2CD311	Genesis with Coil Cord and Accessory Jack	\$ 172.30
V2-G2CD221	Genesis Coil Cord and Emergency Button	\$ 177.50
V2-G2CD321	Genesis Coil Cord, Emergency Button & Accessory Jack	\$ 185.00
<b>EARPHONE KITS FOR USE WITH EVOLUTION AND PROFILE SPEAKER MICROPHONES ONLY</b>		
V1-10282	2.5mm straight plug, coil cord (30" extended length), black	\$ 47.44
V1-10432	2.5mm right angle plug, coil cord (30" extended length), black	\$ 47.44
V1-EH22R131	2.5mm right angle plug, <b>Earhanger</b> , coil cord (30" extended length), black	\$ 26.93
V1-10305	3.5mm straight plug, coil cord (30" extended length), black	\$ 47.44
V1-10433	3.5mm right angle plug, coil cord (30" extended length) black	\$ 47.44
<b>ACCESSORIES FOR GENESIS WITH ACCESSORY JACK OPTION</b>		
V1-10750	Earphone with acoustic tube and Hirose Connector	\$ 91.78
V4-10478	Hurricane, lightweight, dual spkr, 21db reduction, behind-the-head, Hirose Connector	\$ 265.38
V1-10656	Throat Microphone with Hirose Connector	\$ 289.58
V4-10421	Ranger Single Speaker, behind-the-head, NO PTT with Hirose Connector	\$ 291.84
V4-10450	Behind-the-head Dual Speaker Heavy Duty with no PTT	\$ 306.24
V4-10428	Skull Microphone with Hirose Connector	\$ 318.81
V3-10301	SCBA-ISI Hirose Connector Interface Cable	\$ 115.38
<b>TACTICAL, FIRE, &amp; HAZMAT COMMUNICATIONS EQUIPMENT</b>		
V1-T12CD137	Throat Microphone with Acoustic Tube & 80 MM PTT	\$ 445.00
V4-10399	Skull Microphone with Earcup & 80 MM PTT	\$ 572.69

**CONSULT TABLE OF CONTENTS FOR REPLACEMENT PARTS & ADDITIONAL EAR INSERT OPTIONS**

**CONTACT FACTORY FOR ALL INTRINSICALLY SAFE APPROVED PRODUCTS**

# Icom

F50, F51, F60, F61

Multi Pin Molded Connector



PART NUMBER	DESCRIPTION	SUGGESTED RESALE
<b>SURVEILLANCE KITS</b>		
V1-10745	2 Wire Palm Microphone Kit <b>Black</b>	\$ 99.80
V1-10746	3 Wire Mini Lapel Microphone Kit <b>Black</b>	\$ 171.00
<b>EAR INSERT OPTIONS</b> <i>Consult table of contents for additional Ear Insert Options</i>		
C800947	Regular Clear Ear Tip	\$ 1.06
C100733	Noise Attenuating Plugs ( <b>NRR 25dB</b> )	\$ 2.33
C806573-LM	Flexible Open Ear Inserts Left, Medium	\$ 15.38
C806573-RM	Flexible Open Ear Inserts Right, Medium	\$ 15.38
V1-10610	Wireless Ear Receiver used with Flat Pack Inductor (Conventional Version)	\$ 202.44
V1-10611	Wireless Ear Receiver used with Flat Pack Inductor (Squelched Version)	\$ 260.86
V1-10471	Flat Pack Inductor with 2 prong jack for use with existing 2 & 3 Wire Kits	\$ 70.73
V1-10666	28" Universal neck loop	\$ 70.73
V1-10603	49" Universal neck loop	\$ 80.98
C819021	Replacement batteries (4) for Wireless Ear Receiver	\$ 11.26
C101114	Wax Trap (15) and Installation Tool (Replacement Part for Wireless Ear Receiver)	\$ 18.96
<b>HEADSETS</b>		
V4-EX2CE1	Explorer, lightweight, flexible earloop, w/ boom mic, quick-disconnect acoustic tube, Std. PTT	\$ 101.20
V4-BA2CE1	Breeze, lightweight, behind-the-head, single spkr with standard PTT	\$ 91.25
V4-10471	Lightweight Single Speaker Padded Headband with standard PTT	\$ 113.75
V4-HC2CE1	Hurricane, lightweight, dual spkr, 21dB reduction, behind-the-head, with Std. PTT	\$ 248.00
V4-HC2CE3B	Hurricane with Extreme Noise Canceling mic, lightweight, dual spkr, 21dB reduction, behind-the-head, w/ Std. PTT & 2.5mm pigtail for remote PTT	\$ 267.23
V4-NR2CE1	Ranger Single Speaker behind-the-head with standard PTT	\$ 328.00
V4-10469	Over-the-head Dual Speaker Heavy Duty with standard PTT	\$ 287.00
V4-10470	Behind-the-head Dual Speaker Heavy Duty with standard PTT	\$ 335.00
<b>SPEAKER MICROPHONES</b>		
V2-L2CE11	Profile Speaker Microphone with 2.5mm earphone jack	\$ 74.67
V2-10274	Evolution Speaker Mic with Coil cord, volume control and 2.5mm earphone jack	\$ 100.52
V2-10278	Evolution Speaker Mic with Coil cord, volume control, 2.5mm earphone jack and emergency button ( <b>F51/F61 Only</b> )	\$ 109.10
V2-10273	Evolution H20 Immersion Rated (IP68), with Coil Cord and volume control	\$ 121.00
V2-G2CE211	Genesis with Coil Cord	\$ 165.30
V2-G2CE311	Genesis with Coil Cord & Accessory Jack	\$ 179.25
V2-G2CE221	Genesis Coil Cord and Emergency Button ( <b>F51/F61 Only</b> )	\$ 181.46
V2-G2CE321	Genesis Coil Cord, Emergency Button & Accessory Jack ( <b>F51/F61 Only</b> )	\$ 193.77
<b>EARPHONE KITS FOR USE WITH EVOLUTION AND PROFILE REMOTE SPEAKER MICROPHONES ONLY</b>		
V1-10282	2.5mm straight plug, coil cord (30" extended length), black	\$ 47.44
V1-10432	2.5mm right angle plug, coil cord (30" extended length), black	\$ 47.44
V1-EH22R131	2.5mm right angle plug, <b>Earhanger</b> , coil cord (30" extended length), black	\$ 26.93
V1-10305	3.5mm straight plug, coil cord (30" extended length), black	\$ 47.44
V1-10433	3.5mm right angle plug, coil cord (30" extended length) black	\$ 47.44
<b>ACCESSORIES FOR GENESIS WITH ACCESSORY JACK OPTION</b>		
V1-10750	Earphone with acoustic tube and Hirose Connector	\$ 91.78
V4-10478	Hurricane, lightweight, dual spkr, 21db reduction, behind-the-head, Hirose Connector	\$ 265.38
V1-10656	Throat Microphone with Hirose Connector	\$ 289.58
V4-10421	Ranger Single Speaker, behind-the-head, NO PTT with Hirose Connector	\$ 291.84
V4-10450	Behind-the-headset Dual Speaker, NO PTT with Hirose Connector	\$ 306.24
V4-10428	Skull Microphone with Hirose Connector	\$ 318.81
V3-10301	SCBA-ISI Hirose Connector Interface Cable	\$ 115.38
<b>TACTICAL, FIRE, &amp; HAZMAT COMMUNICATIONS EQUIPMENT</b>		
V1-T12CE137	Throat Microphone with Acoustic Tube & 80 MM PTT	\$ 465.00

CONSULT TABLE OF CONTENTS FOR REPLACEMENT PARTS & ADDITIONAL EAR INSERT OPTIONS

CONTACT FACTORY FOR ALL INTRINSICALLY SAFE APPROVED PRODUCTS

# Kenwood

TK-272G/372G, TK3130 ProTalk XLS,TK-3131 Free Talk XLS,  
TK260G/360G,270G/370G, 2100/3100,2160/3160 ProTalk,3101 FreeTalk XL 2102/3102 ProTalk,TK2200/3200

2.5/3.5mm Right Angle Connector



PART NUMBER	DESCRIPTION	SUGGESTED RESALE
-------------	-------------	---------------------

### SURVEILLANCE KITS

V1-10269	1 Wire Earphone Kit <b>Black (Receive only no transmit)</b>	\$ 55.01
V1-10268	1 Wire Earphone Kit <b>Beige (Receive only no transmit)</b>	\$ 55.01
V1-10619	1 Wire Earphone Kit with coil cord, <b>Black</b>	\$ 55.01
V1-B22KA131	2 Wire Earbud <b>Black</b>	\$ 48.43
V1-10267	2 Wire Palm Microphone Kit <b>Black</b>	\$ 88.39
V1-10266	2 Wire Palm Microphone Kit <b>Beige</b>	\$ 88.39
V1-10339	2 Wire Field <b>Repairable</b> Palm Microphone Kit, <b>Black</b>	\$ 127.15
V1-10265	3 Wire Mini Lapel Microphone Kit <b>Black</b>	\$ 142.32
V1-10264	3 Wire Mini Lapel Microphone Kit <b>Beige</b>	\$ 142.32

### EAR INSERT OPTIONS Consult table of contents for additional Ear Insert Options

C800947	Regular Clear Ear Tip	\$ 1.06
C100733	Noise Attenuating Plugs ( <b>NRR 25dB</b> )	\$ 2.33
C806573-LM	Flexible Open Ear Inserts Left, Medium	\$ 15.38
C806573-RM	Flexible Open Ear Inserts Right, Medium	\$ 15.38

### WIRELESS ACCESSORIES FOR USE WITH SURVEILLANCE KITS

V1-10610	Wireless Ear Receiver used with Flat Pack Inductor or Neckloop (Conventional Version)	\$ 202.44
V1-10611	Wireless Ear Receiver used with Flat Pack Inductor or Neckloop (Squelched Version)	\$ 260.86
V1-10471	Flat Pack Inductor with 2 prong jack for use with existing 2 & 3 Wire Kits	\$ 70.73
V1-10666	28" Universal neck loop	\$ 70.73
V1-10603	49" Universal neck loop	\$ 80.98
C819021	Replacement batteries (4) for Wireless Ear Receiver	\$ 11.26
C101114	Wax Trap (15) and Installation Tool (Replacement Part for Wireless Ear Receiver)	\$ 18.96

### HEADSETS

V4-EX2KA2	Explorer, lightweight, flexible earloop w/boom mic, quick-disconnect acoustic tube, no PTT	\$ 66.49
V4-EX2KA5	Explorer, lightweight, flexible earloop, w/ boom mic, quick-disconnect acoustic tube, mini PTT	\$ 87.88
V4-BA2KA2	Breeze, lightweight, behind-the-head, single spkr, no PTT	\$ 33.12
V4-BA2KA5	Breeze, lightweight, behind-the-head, single spkr with mini PTT	\$ 37.84
V4-BA2KA1	Breeze, lightweight, behind-the-head, single spkr with standard PTT	\$ 55.20
* V4-BA2KA3B	Breeze, lightweight, behind-the-head, single spkr w/std. PTT & 2.5mm pigtail for remote PTT	\$ 86.06
V4-BH2KA2	Breeze, lightweight, behind-the-head, <b>adjustable headband</b> , single spkr, no PTT	\$ 38.07
V4-BH2KA5	Breeze, lightweight, behind-the-head, <b>adjustable headband</b> , single spkr, mini PTT	\$ 42.79
V4-10030	Lightweight Single Speaker Padded Headband no PTT	\$ 59.92
V4-10055	Lightweight Single Speaker Padded Headband with standard PTT	\$ 89.88
V4-HC2KA5	Hurricane, lightweight, dual spkr, 21dB reduction,behind-the-head, with mini PTT	\$ 224.98
V4-NR2KA1	Ranger Single Speaker behind-the-head with standard PTT	\$ 306.48
V4-10018	Over-the-head Dual Speaker Heavy Duty with standard PTT	\$ 287.64
V4-10019	Behind-the-Head Dual Speaker Heavy Duty with standard PTT	\$ 314.59
V4-10413	ClearTRAK Over-the-Head Dual Speaker Extreme Noise with Earcup PTT	\$ 377.92
V4-10025	ClearTRAK Behind-the-Head Dual Speaker Extreme Noise with Earcup PTT	\$ 395.37

### \* REMOTE PTT ACCESSORIES FOR BREEZE HEADSETS WITH 2.5MM JACK

V1-10513	Ring PTT with 2.5mm right angle plug, 5' straight cable	\$ 25.63
V1-10519	80mm Round Body PTT with 2.5mm right angle plug, coil cord	\$ 96.77

continued on page 20

KENWOOD

# Kenwood

TK-272G/372G, TK3130 ProTalk XLS,TK-3131 Free Talk XLS,  
TK260G/360G,270G/370G, 2100/3100,2160/3160 ProTalk,3101 FreeTalk XL 2102/3102 ProTalk,TK2200/3200

PART NUMBER	DESCRIPTION	SUGGESTED RESALE
-------------	-------------	---------------------

## SPEAKER MICROPHONES

V2-C2KA11	Legacy Speaker Microphone with 2.5mm earphone jack	\$ 37.44
V2-L2KA11	Profile Speaker Microphone with 2.5mm earphone jack	\$ 66.23
V2-10030	Evolution Speaker Mic with Coil cord, volume control and 2.5mm earphone jack	\$ 89.18

## EARPHONE KITS FOR USE WITH EVOLUTION AND PROFILE REMOTE SPEAKER MICROPHONES ONLY

V1-10282	2.5mm straight plug, coil cord (30" extended length), black	\$ 47.44
V1-10432	2.5mm right angle plug, coil cord (30" extended length), black	\$ 47.44
V1-EH22R131	2.5mm right angle plug, <b>Earhanger</b> , coil cord (30" extended length), black	\$ 26.93
V1-10758	3.5mm right angle plug, coil cord (30" extended length) black <b>(Recommend for Kenwood Microphones Only)</b>	\$ 47.44

## EARPHONE KIT FOR USE WITH LEGACY SPEAKER MICROPHONE ONLY

V1-10598	2.5mm straight plug, coil cord (12" length), black	\$ 29.95
----------	--	----------

## TACTICAL, FIRE, & HAZMAT COMMUNICATIONS EQUIPMENT

V1-T12KA137	Throat Microphone with Acoustic Tube & 80 MM PTT	\$ 439.73
V1-T12KA117	Throat Microphone with Acoustic Tube and Remote Ring PTT	\$ 496.10
V4-10373	Skull Microphone with Earcup & 80 MM PTT	\$ 562.73

*CONSULT TABLE OF CONTENTS FOR REPLACEMENT PARTS & ADDITIONAL EAR INSERT OPTIONS*

*CONTACT FACTORY FOR ALL INTRINSICALLY SAFE APPROVED PRODUCTS*

# Kenwood

TK480/481, TK290/390, TK280/380, TK-2140/3140, TK190, TK2180/3180, TK5400, TK5210

Assembled Connector



PART NUMBER	DESCRIPTION	SUGGESTED RESALE
-------------	-------------	---------------------

## SURVEILLANCE KITS

V1-10247*	1 Wire Earphone Kit, 2.5mm jack, 48" cable, <b>Black (Receive only no transmit)</b>	\$ 44.23
V1-10245*	1 Wire Earphone Kit, 2.5mm jack, 48" cable, <b>Beige (Receive only no transmit)</b>	\$ 44.23
V1-10291*	1 Wire Earphone Kit, 2.5mm jack, 30" cable, <b>Black (Receive only no transmit)</b>	\$ 44.53
V1-10695	2 Wire Palm Microphone Kit <b>Black</b>	\$ 95.16
V1-10355	2 Wire Field <b>Repairable</b> Palm Microphone Kit <b>Black</b>	\$ 133.93
V1-10354	2 Wire Palm Microphone Kit <b>Beige</b>	\$ 95.16
V1-10357	3 Wire Mini Lapel Microphone Kit <b>Black</b>	\$ 157.30
V1-10356	3 Wire Mini Lapel Microphone Kit <b>Beige</b>	\$ 157.30
V1-10430	*Adapter required with use of 1 Wire Earphone Kits above	\$ 51.66

## EAR INSERT OPTIONS *Consult table of contents for additional Ear Insert Options*

C800947	Regular Clear Ear Tip	\$ 1.06
C100733	Noise Attenuating Plugs ( <b>NRR 25dB</b> )	\$ 2.33
C806573-LM	Flexible Open Ear Inserts Left, Medium	\$ 15.38
C806573-RM	Flexible Open Ear Inserts Right, Medium	\$ 15.38

## WIRELESS ACCESSORIES FOR USE WITH SURVEILLANCE KITS

V1-10610	Wireless Ear Receiver used with Flat Pack Inductor or Neckloop (Conventional Version)	\$ 202.44
V1-10611	Wireless Ear Receiver used with Flat Pack Inductor or Neckloop (Squelched Version)	\$ 260.86
V1-10471	Flat Pack Inductor with 2 prong jack for use with existing 2 & 3 Wire Kits	\$ 70.73
V1-10666	28" Universal neck loop	\$ 70.73
V1-10603	49" Universal neck loop	\$ 80.98
C819021	Replacement batteries (4) for Wireless Ear Receiver	\$ 11.26
C101114	Wax Trap (15) and Installation Tool (Replacement Part for Wireless Ear Receiver)	\$ 18.96

## HEADSETS

V4-EX2KB1	Explorer, lightweight, flexible earloop, w/ boom mic, quick-disconnect acoustic tube, Std. PTT	\$ 93.15
V4-BA2KB1	Breeze, lightweight, behind-the-head, single spkr with standard PTT	\$ 90.39
* V4-BA2KB3B	Breeze, lightweight, behind-the-head, single spkr w/std. PTT & 2.5mm pigtail for remote PTT	\$ 98.79
V4-10076	Lightweight Single Speaker Padded Headband with standard PTT	\$ 107.86
V4-HC2KB1	Hurricane, lightweight, dual spkr, 21dB reduction, behind-the-head, with Std. PTT	\$ 239.98
* V4-HC2KB3B	Hurricane, lightweight, dual spkr, 21dB reduction, behind-the-head, w/Std. PTT & 2.5mm pigtail for remote PTT	\$ 249.17
*V4-HE2KB3B	Hurricane with Extreme Noise Canceling mic, lightweight, dual spkr, 21dB reduction, behind-the-head, w/ Std. PTT & 2.5mm pigtail for remote PTT	\$ 269.17
V4-NR2KB1	Ranger Single Speaker behind-the-head with standard PTT	\$ 388.48
V4-10080	Over-the-head Dual Speaker Heavy Duty with standard PTT	\$ 291.74
V4-10081	Behind-the-Head Dual Speaker Heavy Duty with standard PTT	\$ 359.54
V4-10415	ClearTRAK Over-the-Head Dual Speaker Extreme Noise with Earcup PTT	\$ 370.93
V4-10388	ClearTRAK Behind-the-Head Dual Speaker Extreme Noise with Earcup PTT	\$ 415.87

## \* REMOTE PTT ACCESSORIES FOR BREEZE AND HURRICANE HEADSETS WITH 2.5MM JACK

V1-10513	Ring PTT with 2.5mm right angle plug, 5' straight cable	\$ 25.63
V1-10519	80mm Round Body PTT with 2.5mm right angle plug, coil cord	\$ 96.77

## SPEAKER MICROPHONES

V2-L2KB11	Profile Speaker Microphone with 2.5mm earphone jack	\$ 73.16
V2-10068	Evolution Speaker Mic with Coil cord, volume control and 2.5mm earphone jack	\$ 83.70
V2-10168	Evolution Speaker Mic with Coil cord, Hi for Hi background noise/Lo for low background noise, 2.5mm earphone jack	\$ 107.33
V2-10112	Evolution Speaker Mic with Coiled Coaxial cord, volume control, 2.5mm earphone jack, antenna connector and emergency button ( <b>TK290/390 radios only</b> )	\$ 99.87
V2-10241	Evolution Speaker Mic with Coiled Coaxial cord, volume control and 2.5mm earphone jack	\$ 97.77
V2-10134	Evolution H20 Immersion Rated (IP68), with Coil Cord, volume control	\$ 104.20
V2-10240	Evolution H20 Immersion Rated (IP68), with Coiled Coaxial Cord and volume control	\$ 109.32
V2-G2KB211	Genesis with Coil Cord	\$ 110.68
V2-G2KB311	Genesis with Coil Cord & Accessory Jack	\$ 125.68
V2-G2KB321	Genesis with Coil Cord, emergency button and Accessory Jack	\$ 158.57

continued on page 22

# Kenwood

TK480/481, TK290/390, TK280/380, TK-2140/3140, TK190, TK2180/3180, TK5400, TK5210

PART NUMBER	DESCRIPTION	SUGGESTED RESALE
-------------	-------------	---------------------

## EARPHONE KITS FOR USE WITH EVOLUTION AND PROFILE SPEAKER MICROPHONES ONLY

V1-10282	2.5mm straight plug, coil cord (30" extended length), black	\$ 47.44
V1-10432	2.5mm right angle plug, coil cord (30" extended length), black	\$ 47.44
V1-EH22R131	2.5mm right angle plug, <b>Earhanger</b> , coil cord (30" extended length), black	\$ 26.93
V1-10758	3.5mm right angle plug, coil cord (30" extended length) black <b>(Recommend for Kenwood Microphones Only)</b>	\$ 47.44

## ACCESSORIES FOR GENESIS WITH ACCESSORY JACK OPTION

V1-10750	Earphone with acoustic tube and Hirose Connector	\$ 91.78
V4-10478	Hurricane, lightweight, dual sprk, 21db reduction, behind-the-head with Hirose Connector	\$ 265.38
V1-10656	Throat Microphone with Hirose Connector	\$ 289.58
V4-10421	Ranger Single Speaker, behind-the-head, NO PTT with Hirose Connector	\$ 291.84
V4-10450	Behind-the-head Dual Speaker Heavy Duty with no PTT	\$ 306.24
V4-10428	Skull Microphone with Hirose Connector	\$ 318.81
V3-10301	SCBA-ISI Hirose Connector Interface Cable	\$ 115.38

## TACTICAL, FIRE, & HAZMAT COMMUNICATIONS EQUIPMENT

V1-T12KB137	Throat Microphone with Acoustic Tube & 80 MM PTT	\$ 470.48
V4-10319	Skull Microphone with Earcup & 80 MM PTT	\$ 562.73

*CONSULT TABLE OF CONTENTS FOR REPLACEMENT PARTS & ADDITIONAL EAR INSERT OPTIONS*

*CONTACT FACTORY FOR ALL INTRINSICALLY SAFE APPROVED PRODUCTS*

# M/A-Com

## EDACS 300P

Assembled Connector



PART NUMBER	DESCRIPTION	SUGGESTED RESALE
-------------	-------------	---------------------

### SURVEILLANCE KITS

V1-10569	1 Wire Earphone Kit <b>Black (Receive only no transmit)</b>	\$ 81.85
V1-10568	1 Wire Earphone Kit <b>Beige (Receive only no transmit)</b>	\$ 81.85
V1-10571	2 Wire Palm Microphone Kit <b>Black</b>	\$ 146.35
V1-10570	2 Wire Palm Microphone Kit <b>Beige</b>	\$ 146.35
V1-10573	3 Wire Mini Lapel Microphone Kit <b>Black</b>	\$ 153.12
V1-10572	3 Wire Mini Lapel Microphone Kit <b>Beige</b>	\$ 153.12

### EAR INSERT OPTIONS *Consult table of contents for additional Ear Insert Options*

C800947	Regular Clear Ear Tip	\$ 1.06
C100733	Noise Attenuating Plugs ( <b>NRR 25dB</b> )	\$ 2.33
C806573-LM	Flexible Open Ear Inserts Left, Medium	\$ 15.38
C806573-RM	Flexible Open Ear Inserts Right, Medium	\$ 15.38

### WIRELESS ACCESSORIES FOR USE WITH SURVEILLANCE KITS

V1-10610	Wireless Ear Receiver used with Flat Pack Inductor or Neckloop (Conventional Version)	\$ 202.44
V1-10611	Wireless Ear Receiver used with Flat Pack Inductor or Neckloop (Squelched Version)	\$ 260.86
V1-10471	Flat Pack Inductor with 2 prong jack for use with existing 2 & 3 Wire Kits	\$ 70.73
V1-10666	28" Universal neck loop	\$ 70.73
V1-10603	49" Universal neck loop	\$ 80.98
C819021	Replacement batteries (4) for Wireless Ear Receiver	\$ 11.26
C101114	Wax Trap (15) and Installation Tool (Replacement Part for Wireless Ear Receiver)	\$ 18.96

### HEADSETS

V4-BA2EP1	Breeze, lightweight, behind-the-head, single spkr with standard PTT	\$ 113.87
* V4-BA2EP3B	Breeze, lightweight, behind-the-head, single spkr w/std. PTT & 2.5mm pigtail for remote PTT	\$ 121.86
V4-10362	Lightweight Single Speaker Padded Headband with no PTT	\$ 137.20
V4-10386	Over-the-head Dual Speaker Heavy Duty with standard PTT	\$ 306.12
V4-10387	Behind-the-Head Dual Speaker Heavy Duty with standard PTT	\$ 323.37

### \* REMOTE PTT ACCESSORIES FOR BREEZE HEADSETS WITH 2.5MM JACK

V1-10513	Ring PTT with 2.5mm right angle plug, 5' straight cable	\$ 25.63
V1-10519	80mm Round Body PTT with 2.5mm right angle plug, coil cord	\$ 96.77

### SPEAKER MICROPHONES

V2-L2EP11	Profile Speaker Microphone with 2.5mm earphone jack	\$ 69.68
V2-10158	Evolution Speaker Mic with Coil cord, volume control and 2.5mm earphone jack	\$ 117.41

### EARPHONE KITS FOR USE WITH EVOLUTION AND PROFILE SPEAKER MICROPHONES ONLY

V1-10282	2.5mm straight plug, coil cord (30" extended length), black	\$ 47.44
V1-10432	2.5mm right angle plug, coil cord (30" extended length), black	\$ 47.44
V1-EH22R131	2.5mm right angle plug, <b>Earhanger</b> , coil cord (30" extended length), black	\$ 26.93
V1-10305	3.5mm straight plug, coil cord (30" extended length), black	\$ 47.44
V1-10433	3.5mm right angle plug, coil cord (30" extended length) black	\$ 47.44

**CONSULT TABLE OF CONTENTS FOR REPLACEMENT PARTS & ADDITIONAL EAR INSERT OPTIONS**

**CONTACT FACTORY FOR ALL INTRINSICALLY SAFE APPROVED PRODUCTS**

# M/A-Com Monogram

6 pin Hirose Connector



PART NUMBER	DESCRIPTION	SUGGESTED RESALE
-------------	-------------	---------------------

## SURVEILLANCE KITS

1 Wire earphone kit is not compatible with the Monogram portable radio due to radio circuitry.

V1-10155	2 Wire Palm Microphone Kit <b>Black</b>	\$ 109.20
V1-10157	2 Wire Palm Microphone Kit <b>Beige</b>	\$ 109.20
V1-10159	3 Wire Mini Lapel Microphone Kit <b>Black</b>	\$ 121.06
V1-10160	3 Wire Mini Lapel Microphone Kit <b>Beige</b>	\$ 121.06

## EAR INSERT OPTIONS *Consult table of contents for additional Ear Insert Options*

C800947	Regular Clear Ear Tip	\$ 1.06
C100733	Noise Attenuating Plugs ( <b>NRR 25dB</b> )	\$ 2.33
C806573-LM	Flexible Open Ear Inserts Left, Medium	\$ 15.38
C806573-RM	Flexible Open Ear Inserts Right, Medium	\$ 15.38

## WIRELESS ACCESSORIES FOR USE WITH SURVEILLANCE KITS

V1-10610	Wireless Ear Receiver used with Flat Pack Inductor or Neckloop (Conventional Version)	\$ 202.44
V1-10611	Wireless Ear Receiver used with Flat Pack Inductor or Neckloop (Squelched Version)	\$ 260.86
V1-10471	Flat Pack Inductor with 2 prong jack for use with existing 2 & 3 Wire Kits	\$ 70.73
V1-10666	28" Universal neck loop	\$ 70.73
V1-10603	49" Universal neck loop	\$ 80.98
C819021	Replacement batteries (4) for Wireless Ear Receiver	\$ 11.26
C101114	Wax Trap (15) and Installation Tool (Replacement Part for Wireless Ear Receiver)	\$ 18.96

## HEADSETS

V4-BA2EX2	Breeze, lightweight, behind-the-head, single spkr, no PTT	\$ 65.64
V4-BA2EX1	Breeze, lightweight, behind-the-head, single spkr with standard PTT	\$ 84.20
* V4-BA2EX3B	Breeze, lightweight, behind-the-head, single spkr w/std. PTT & 2.5mm pigtail for remote PTT	\$ 91.38
V4-10184	Lightweight Single Speaker Padded Headband with no PTT	\$ 88.97
V4-10188	Over-the-head Dual Speaker Heavy Duty with standard PTT	\$ 297.12
V4-10008	Behind-the-Head Dual Speaker Heavy Duty with standard PTT	\$ 382.48

## \* REMOTE PTT ACCESSORIES FOR BREEZE HEADSETS WITH 2.5MM JACK

V1-10513	Ring PTT with 2.5mm right angle plug, 5' straight cable	\$ 25.63
V1-10519	80mm Round Body PTT with 2.5mm right angle plug, coil cord	\$ 96.77

## SPEAKER MICROPHONES

V2-10032	Evolution Speaker Mic with Coil cord, volume control and 2.5mm earphone jack	\$ 96.07
----------	--	----------

## EARPHONE KITS FOR USE WITH EVOLUTION AND PROFILE SPEAKER MICROPHONES ONLY

V1-10282	2.5mm straight plug, coil cord (30" extended length), black	\$ 47.44
V1-10432	2.5mm right angle plug, coil cord (30" extended length), black	\$ 47.44
V1-EH22R131	2.5mm right angle plug, <b>Earhanger</b> , coil cord (30" extended length), black	\$ 26.93
V1-10305	3.5mm straight plug, coil cord (30" extended length), black	\$ 47.44
V1-10433	3.5mm right angle plug, coil cord (30" extended length) black	\$ 47.44

CONSULT TABLE OF CONTENTS FOR REPLACEMENT PARTS & ADDITIONAL EAR INSERT OPTIONS

CONTACT FACTORY FOR ALL INTRINSICALLY SAFE APPROVED PRODUCTS



# M/A-Com PCS

Assembled Connector



PART NUMBER	DESCRIPTION	SUGGESTED RESALE
-------------	-------------	---------------------

## SURVEILLANCE KITS

V1-10114	1 Wire Earphone Kit <b>Black (Receive only no transmit)</b>	\$ 101.44
V1-10113	1 Wire Earphone Kit <b>Beige (Receive only no transmit)</b>	\$ 101.44
V1-10116	2 Wire Field <b>Repairable</b> Palm Microphone Kit, <b>Black</b>	\$ 157.43
V1-10115	2 Wire Palm Microphone Kit <b>Beige</b>	\$ 157.43
V1-10118	3 Wire Mini Lapel Microphone Kit <b>Black</b>	\$ 195.12
V1-10117	3 Wire Mini Lapel Microphone Kit <b>Beige</b>	\$ 195.12

## EAR INSERT OPTIONS *Consult table of contents for additional Ear Insert Options*

C800947	Regular Clear Ear Tip	\$ 1.06
C100733	Noise Attenuating Plugs ( <b>NRR 25dB</b> )	\$ 2.33
C806573-LM	Flexible Open Ear Inserts Left, Medium	\$ 15.38
C806573-RM	Flexible Open Ear Inserts Right, Medium	\$ 15.38

## WIRELESS ACCESSORIES FOR USE WITH SURVEILLANCE KITS

V1-10610	Wireless Ear Receiver used with Flat Pack Inductor or Neckloop (Conventional Version)	\$ 202.44
V1-10611	Wireless Ear Receiver used with Flat Pack Inductor or Neckloop (Squelched Version)	\$ 260.86
V1-10471	Flat Pack Inductor with 2 prong jack for use with existing 2 & 3 Wire Kits	\$ 70.73
V1-10666	28" Universal neck loop	\$ 70.73
V1-10603	49" Universal neck loop	\$ 80.98
C819021	Replacement batteries (4) for Wireless Ear Receiver	\$ 11.26
C101114	Wax Trap (15) and Installation Tool (Replacement Part for Wireless Ear Receiver)	\$ 18.96

## HEADSETS

V4-BA2EE1	Breeze, lightweight, behind-the-head, single spkr with standard PTT	\$ 93.08
V4-10187	Lightweight Single Speaker Padded Headband with standard PTT	\$ 116.41
V4-10149	Over-the-head Dual Speaker Heavy Duty with standard PTT	\$ 305.98
V4-10005	Behind-the-Head Dual Speaker Heavy Duty with standard PTT	\$ 391.35

## SPEAKER MICROPHONES

V2-10045	Evolution Speaker Mic with Coil cord, volume control and 2.5mm earphone jack	\$ 99.94
----------	--	----------

## EARPHONE KITS FOR USE WITH EVOLUTION AND PROFILE SPEAKER MICROPHONES ONLY

V1-10282	2.5mm straight plug, coil cord (30" extended length), black	\$ 47.44
V1-10432	2.5mm right angle plug, coil cord (30" extended length), black	\$ 47.44
V1-EH22R131	2.5mm right angle plug, <b>Earhanger</b> , coil cord (30" extended length), black	\$ 26.93
V1-10305	3.5mm straight plug, coil cord (30" extended length), black	\$ 47.44
V1-10433	3.5mm right angle plug, coil cord (30" extended length) black	\$ 47.44

**CONSULT TABLE OF CONTENTS FOR REPLACEMENT PARTS & ADDITIONAL EAR INSERT OPTIONS  
CONTACT FACTORY FOR ALL INTRINSICALLY SAFE APPROVED PRODUCTS**

# M/A-Com

## KPC / Panther 500P

Assembled Connector



PART NUMBER	DESCRIPTION	SUGGESTED RESALE
-------------	-------------	---------------------

### SURVEILLANCE KITS

V1-10279	1 Wire Earphone Kit <b>Black (Receive only no transmit)</b>	\$ 79.54
V1-10278	1 Wire Earphone Kit <b>Beige (Receive only no transmit)</b>	\$ 79.54
V1-10277	2 Wire Palm Microphone Kit <b>Black</b>	\$ 116.41
V1-10276	2 Wire Palm Microphone Kit <b>Beige</b>	\$ 116.41
V1-10275	3 Wire Mini Lapel Microphone Kit <b>Black</b>	\$ 169.62
V1-10274	3 Wire Mini Lapel Microphone Kit <b>Beige</b>	\$ 169.62

### EAR INSERT OPTIONS Consult table of contents for additional Ear Insert Options

C800947	Regular Clear Ear Tip	\$ 1.06
C100733	Noise Attenuating Plugs ( <b>NRR 25dB</b> )	\$ 2.33
C806573-LM	Flexible Open Ear Inserts Left, Medium	\$ 15.38
C806573-RM	Flexible Open Ear Inserts Right, Medium	\$ 15.38

### WIRELESS ACCESSORIES FOR USE WITH SURVEILLANCE KITS

V1-10610	Wireless Ear Receiver used with Flat Pack Inductor or Neckloop (Conventional Version)	\$ 202.44
V1-10611	Wireless Ear Receiver used with Flat Pack Inductor or Neckloop (Squelched Version)	\$ 260.86
V1-10471	Flat Pack Inductor with 2 prong jack for use with existing 2 & 3 Wire Kits	\$ 70.73
V1-10666	28" Universal neck loop	\$ 70.73
V1-10603	49" Universal neck loop	\$ 80.98
C819021	Replacement batteries (4) for Wireless Ear Receiver	\$ 11.26
C101114	Wax Trap (15) and Installation Tool (Replacement Part for Wireless Ear Receiver)	\$ 18.96

### HEADSETS

V4-BA2EF2	Breeze, lightweight, behind-the-head, single spkr, no PTT	\$ 62.04
V4-BA2EF1	Breeze, lightweight, behind-the-head, single spkr with standard PTT	\$ 85.36
V4-10026	Lightweight Single Speaker Padded Headband with no PTT	\$ 85.36
V4-10021	Over-the-head Dual Speaker Heavy Duty with PTT	\$ 304.88
V4-10022	Behind-the-Head Dual Speaker Heavy Duty with PTT	\$ 352.55

### SPEAKER MICROPHONES

V2-L2EF11	Profile Speaker Microphone with 2.5mm earphone jack	\$ 63.08
V2-10044	Evolution Speaker Mic with Coil cord, volume control and 2.5mm earphone jack	\$ 94.69

### EARPHONE KITS FOR USE WITH EVOLUTION AND PROFILE REMOTE SPEAKER MICROPHONES ONLY

V1-10282	2.5mm straight plug, coil cord (30" extended length), black	\$ 47.44
V1-10432	2.5mm right angle plug, coil cord (30" extended length), black	\$ 47.44
V1-EH22R131	2.5mm right angle plug, <b>Earhanger</b> , coil cord (30" extended length), black	\$ 26.93
V1-10305	3.5mm straight plug, coil cord (30" extended length), black	\$ 47.44
V1-10433	3.5mm right angle plug, coil cord (30" extended length) black	\$ 47.44

**CONSULT TABLE OF CONTENTS FOR REPLACEMENT PARTS & ADDITIONAL EAR INSERT OPTIONS**

**CONTACT FACTORY FOR ALL INTRINSICALLY SAFE APPROVED PRODUCTS**

# M/A-Com

MPA / MPD

Assembled Connector



PART NUMBER	DESCRIPTION	SUGGESTED RESALE
-------------	-------------	---------------------

## SURVEILLANCE KITS

V1-10108	1 Wire Earphone Kit <b>Black (Receive only no transmit)</b>	\$ 110.86
V1-10107	1 Wire Earphone Kit <b>Beige (Receive only no transmit)</b>	\$ 110.86
V1-10110	2 Wire Field <b>Repairable</b> Palm Microphone Kit, <b>Black</b>	\$ 205.10
V1-10109	2 Wire Palm Microphone Kit <b>Beige</b>	\$ 205.10
V1-10112	3 Wire Mini Lapel Microphone Kit <b>Black</b>	\$ 223.94
V1-10111	3 Wire Mini Lapel Microphone Kit <b>Beige</b>	\$ 223.94

## EAR INSERT OPTIONS *Consult table of contents for additional Ear Insert Options*

C800947	Regular Clear Ear Tip	\$ 1.06
C100733	Noise Attenuating Plugs ( <b>NRR 25dB</b> )	\$ 2.33
C806573-LM	Flexible Open Ear Inserts Left, Medium	\$ 15.38
C806573-RM	Flexible Open Ear Inserts Right, Medium	\$ 15.38

## WIRELESS ACCESSORIES FOR USE WITH SURVEILLANCE KITS

V1-10610	Wireless Ear Receiver used with Flat Pack Inductor or Neckloop (Conventional Version)	\$ 202.44
V1-10611	Wireless Ear Receiver used with Flat Pack Inductor or Neckloop (Squelched Version)	\$ 260.86
V1-10471	Flat Pack Inductor with 2 prong jack for use with existing 2 & 3 Wire Kits	\$ 70.73
V1-10666	28" Universal neck loop	\$ 70.73
V1-10603	49" Universal neck loop	\$ 80.98
C819021	Replacement batteries (4) for Wireless Ear Receiver	\$ 11.26
C101114	Wax Trap (15) and Installation Tool (Replacement Part for Wireless Ear Receiver)	\$ 18.96

## HEADSETS

V4-BA2EB1	Breeze, lightweight, behind-the-head, single spkr with standard PTT	\$ 98.07
V4-10186	Lightweight Single Speaker Padded Headband with standard PTT	\$ 121.40
V4-10151	Over-the-head Dual Speaker Heavy Duty with standard PTT	\$ 315.97
V4-10007	Behind-the-Head Dual Speaker Heavy Duty with standard PTT	\$ 401.33

## SPEAKER MICROPHONES

V2-10281	Evolution Speaker Mic with Coil cord, volume control and 2.5mm earphone jack	\$ 101.32
V2-10048	Evolution Speaker Mic with Coil cord, volume control, emergency button and 2.5mm earphone jack	\$ 106.32
V2-10049	Evolution Speaker Mic with Straight Coaxial cord, volume control, 2.5mm earphone jack, antenna connector and emergency button	\$ 157.88

## EARPHONE KITS FOR USE WITH EVOLUTION AND PROFILE REMOTE SPEAKER MICROPHONES ONLY

V1-10282	2.5mm straight plug, coil cord (30" extended length), black	\$ 47.44
V1-10432	2.5mm right angle plug, coil cord (30" extended length), black	\$ 47.44
V1-EH22R131	2.5mm right angle plug, <b>Earhanger</b> , coil cord (30" extended length), black	\$ 26.93
V1-10305	3.5mm straight plug, coil cord (30" extended length), black	\$ 47.44
V1-10433	3.5mm right angle plug, coil cord (30" extended length) black	\$ 47.44

**CONSULT TABLE OF CONTENTS FOR REPLACEMENT PARTS & ADDITIONAL EAR INSERT OPTIONS  
CONTACT FACTORY FOR ALL INTRINSICALLY SAFE APPROVED PRODUCTS**

# M/A-Com

## MRK

Assembled Connector



PART NUMBER	DESCRIPTION	SUGGESTED RESALE
-------------	-------------	---------------------

### SURVEILLANCE KITS

V1-10102	1 Wire Earphone Kit <b>Black (Receive only no transmit)</b>	\$ 130.82
V1-10101	1 Wire Earphone Kit <b>Beige (Receive only no transmit)</b>	\$ 130.82
V1-10218	2 Wire Field <b>Repairable</b> Palm Microphone Kit <b>Black</b>	\$ 217.21
V1-10217	2 Wire Palm Microphone Kit <b>Beige</b>	\$ 217.21
V1-10220	3 Wire Mini Lapel Microphone Kit <b>Black</b>	\$ 238.35
V1-10219	3 Wire Mini Lapel Microphone Kit <b>Beige</b>	\$ 238.35

### EAR INSERT OPTIONS *Consult table of contents for additional Ear Insert Options*

C800947	Regular Clear Ear Tip	\$ 1.06
C100733	Noise Attenuating Plugs ( <b>NRR 25dB</b> )	\$ 2.33
C806573-LM	Flexible Open Ear Inserts Left, Medium	\$ 15.38
C806573-RM	Flexible Open Ear Inserts Right, Medium	\$ 15.38

### WIRELESS ACCESSORIES FOR USE WITH SURVEILLANCE KITS

V1-10610	Wireless Ear Receiver used with Flat Pack Inductor or Neckloop (Conventional Version)	\$ 202.44
V1-10611	Wireless Ear Receiver used with Flat Pack Inductor or Neckloop (Squelched Version)	\$ 260.86
V1-10471	Flat Pack Inductor with 2 prong jack for use with existing 2 & 3 Wire Kits	\$ 70.73
V1-10666	28" Universal neck loop	\$ 70.73
V1-10603	49" Universal neck loop	\$ 80.98
C819021	Replacement batteries (4) for Wireless Ear Receiver	\$ 11.26
C101114	Wax Trap (15) and Installation Tool (Replacement Part for Wireless Ear Receiver)	\$ 18.96

### HEADSETS

V4-EX2EC1	Explorer, lightweight, flexible earloop, w/ boom mic, quick-disconnect acoustic tube & std. PTT	\$ 125.26
V4-BA2EC1	Breeze, lightweight, behind-the-head, single spkr with standard PTT	\$ 113.87
* V4-BA2EC3B	Breeze, lightweight, behind-the-head, single spkr w/std. PTT & 2.5mm pigtail for remote PTT	\$ 121.86
V4-10185	Lightweight Single Speaker Padded Headband with standard PTT	\$ 137.20
V4-HC2EC1	Hurricane, lightweight, dual spkr, 21dB reduction, behind-the-head, with std. PTT	\$ 245.98
V4-NR2EC1	Ranger Single Speaker behind-the-head with standard PTT	\$ 316.73
V4-10150	Over-the-head Dual Speaker Heavy Duty with standard PTT	\$ 321.50
V4-10006	Behind-the-Head Dual Speaker Heavy Duty with standard PTT	\$ 376.12
V4-10313	ClearTRAK Behind-the-Head Dual Speaker Extreme Noise with Earcup PTT	\$ 415.87

### \* REMOTE PTT ACCESSORIES FOR BREEZE HEADSETS WITH 2.5MM JACK

V1-10513	Ring PTT with 2.5mm right angle plug, 5' straight cable	\$ 25.63
V1-10519	80mm Round Body PTT with 2.5mm right angle plug, coil cord	\$ 96.77

### SPEAKER MICROPHONES

V2-10046	Evolution Speaker Mic with Coil cord, volume control, emergency button and 2.5mm earphone jack	\$ 117.41
V2-10105	Evolution Speaker Mic with Coil cord, water resistant grill and 2.5mm earphone jack in UDC	\$ 136.92
V2-10047	Evolution Speaker Mic with Straight Coaxial cord, volume control, 2.5mm earphone jack and antenna connector	\$ 147.34
V2-10102	Evolution Speaker Mic with Coiled Coaxial cord, volume control, emergency button, 2.5mm earphone jack and antenna connector	\$ 211.74
V2-G2EC211	Genesis with Coil Cord	\$ 143.57
V2-G2EC311	Genesis with Coil Cord & Accessory Jack	\$ 158.57

### EARPHONE KITS FOR USE WITH EVOLUTION AND PROFILE REMOTE SPEAKER MICROPHONES ONLY

V1-10282	2.5mm straight plug, coil cord (30" extended length), black	\$ 47.44
V1-10432	2.5mm right angle plug, coil cord (30" extended length), black	\$ 47.44
V1-EH22R131	2.5mm right angle plug, <b>Earhanger</b> , coil cord (30" extended length), black	\$ 26.93
V1-10305	3.5mm straight plug, coil cord (30" extended length), black	\$ 47.44
V1-10433	3.5mm right angle plug, coil cord (30" extended length) black	\$ 47.44

**M/A-Com**  
MRK

PART NUMBER	DESCRIPTION	SUGGESTED RESALE
-------------	-------------	---------------------

**ACCESSORIES FOR GENESIS WITH ACCESSORY JACK OPTION**

V1-10750	Earphone with acoustic tube and Hirose Connector	\$ 91.78
V4-10478	Hurricane, lightweight, dual sprk, 21db reduction, behind-the-head with Hirose Connector	\$ 265.38
V1-10656	Throat Microphone with Hirose Connector	\$ 289.58
V4-10421	Ranger Single Speaker, behind-the-head, NO PTT with Hirose Connector	\$ 291.84
V4-10450	Behind-the-head Dual Speaker Heavy Duty with no PTT	\$ 306.24
V4-10428	Skull Microphone with Hirose Connector	\$ 318.81
V3-10301	SCBA-ISI Hirose Connector Interface Cable	\$ 115.38

**TACTICAL, FIRE, & HAZMAT COMMUNICATIONS EQUIPMENT**

V1-T12EC137	Throat Microphone with Acoustic Tube & 80 MM PTT	\$ 470.48
V4-10320	Skull Microphone with Earcup & 80 MM PTT	\$ 562.73

**CONSULT TABLE OF CONTENTS FOR REPLACEMENT PARTS & ADDITIONAL EAR INSERT OPTIONS**

**CONTACT FACTORY FOR ALL INTRINSICALLY SAFE APPROVED PRODUCTS**

# M/A-Com

## Prism / LPE

Assembled Connector



PART NUMBER	DESCRIPTION	SUGGESTED RESALE
-------------	-------------	------------------

### SURVEILLANCE KITS

V1-10368	1 Wire Earphone Kit <b>Black (Receive only no transmit)</b>	\$ 130.82
V1-10367	1 Wire Earphone Kit <b>Beige (Receive only no transmit)</b>	\$ 130.82
V1-10370	2 Wire Field <b>Repairable</b> Palm Microphone Kit <b>Black</b>	\$ 217.29
V1-10369	2 Wire Palm Microphone Kit <b>Beige</b>	\$ 217.29
V1-10372	3 Wire Mini Lapel Microphone Kit <b>Black</b>	\$ 238.35
V1-10371	3 Wire Mini Lapel Microphone Kit <b>Beige</b>	\$ 238.35

### EAR INSERT OPTIONS *Consult table of contents for additional Ear Insert Options*

C800947	Regular Clear Ear Tip	\$ 1.06
C100733	Noise Attenuating Plugs ( <b>NRR 25dB</b> )	\$ 2.33
C806573-LM	Flexible Open Ear Inserts Left, Medium	\$ 15.38
C806573-RM	Flexible Open Ear Inserts Right, Medium	\$ 15.38

### WIRELESS ACCESSORIES FOR USE WITH SURVEILLANCE KITS

V1-10610	Wireless Ear Receiver used with Flat Pack Inductor or Neckloop (Conventional Version)	\$ 202.44
V1-10611	Wireless Ear Receiver used with Flat Pack Inductor or Neckloop (Squelched Version)	\$ 260.86
V1-10471	Flat Pack Inductor with 2 prong jack for use with existing 2 & 3 Wire Kits	\$ 70.73
V1-10666	28" Universal neck loop	\$ 70.73
V1-10603	49" Universal neck loop	\$ 80.98
C819021	Replacement batteries (4) for Wireless Ear Receiver	\$ 11.26
C101114	Wax Trap (15) and Installation Tool (Replacement Part for Wireless Ear Receiver)	\$ 18.96

### HEADSETS

V4-EX2ED1	Explorer, lightweight, flexible earloop, w/ boom mic, quick-disconnect acoustic tube & standard PTT	\$ 125.26
V4-BA2ED1	Breeze, lightweight, behind-the-head, single spkr with standard PTT	\$ 113.87
* V4-BA2ED3B	Breeze, lightweight, behind-the-head, single spkr w/std. PTT & 2.5mm pigtail for remote PTT	\$ 121.86
V4-10089	Lightweight Single Speaker Padded Headband with standard PTT	\$ 137.20
V4-HC2ED1	Hurricane, lightweight, dual spkr, 21dB reduction, behind-the-head, unidirectional mic, with Std. PTT	\$ 245.98
*V4-HC2ED3B	Hurricane, lightweight, dual spkr, 21dB reduction, behind-the-head, unidirectional mic, w/std. PTT & 2.5mm pigtail for remote PTT	\$ 252.98
V4-NR2ED1	Ranger Single Speaker behind-the-head with standard PTT	\$ 316.73
V4-10092	Over-the-head Dual Speaker Heavy Duty with standard PTT	\$ 321.50
V4-10093	Behind-the-Head Dual Speaker Heavy Duty with standard PTT	\$ 406.87

### \* REMOTE PTT ACCESSORIES FOR BREEZE AND HURRICANE HEADSETS WITH 2.5MM JACK

V1-10513	Ring PTT with 2.5mm right angle plug, 5' straight cable	\$ 25.63
V1-10519	80mm Round Body PTT with 2.5mm right angle plug, coil cord	\$ 96.77

### SPEAKER MICROPHONES

V2-10069	Evolution Speaker Mic with Coil cord, volume control, emergency button and 2.5mm earphone jack	\$ 117.41
V2-10070	Evolution Speaker Mic with Straight Coaxial cord, volume control, emergency button, 2.5mm earphone jack and antenna connector	\$ 147.34
V2-10107	Evolution Speaker Mic with Coiled Coaxial cord, volume control, emergency button 2.5mm earphone jack and antenna connector	\$ 211.74
V2-G2ED211	Genesis with Coil Cord	\$ 143.57
V2-G2ED311	Genesis with Coil Cord & Accessory Jack	\$ 158.57
V2-G2ED222	Genesis Coiled Coax Cable, Antenna Connector & Emergency Button	\$ 170.00

**M/A-Com**  
Prism / LPE

PART NUMBER	DESCRIPTION	SUGGESTED RESALE
-------------	-------------	---------------------

**EARPHONE KITS FOR USE WITH EVOLUTION AND PROFILE REMOTE SPEAKER MICROPHONES ONLY**

V1-10282	2.5mm straight plug, coil cord (30" extended length), black	\$ 47.44
V1-10432	2.5mm right angle plug, coil cord (30" extended length), black	\$ 47.44
V1-EH22R131	2.5mm right angle plug, <b>Earhanger</b> , coil cord (30" extended length), black	\$ 26.93
V1-10305	3.5mm straight plug, coil cord (30" extended length), black	\$ 47.44
V1-10433	3.5mm right angle plug, coil cord (30" extended length) black	\$ 47.44

**ACCESSORIES FOR GENESIS WITH ACCESSORY JACK OPTION**

V1-10750	Earphone with acoustic tube and Hirose Connector	\$ 91.78
V4-10478	Hurricane, lightweight, dual sprk, 21db reduction, behind-the-head with Hirose Connector	\$ 265.38
V1-10656	Throat Microphone with Hirose Connector	\$ 289.58
V4-10421	Ranger Single Speaker, behind-the-head, no PTT with Hirose Connector	\$ 291.84
V4-10450	Behind-the-head Dual Speaker Heavy Duty with no PTT	\$ 306.24
V4-10428	Skull Microphone with Hirose Connector	\$ 318.81
V3-10301	SCBA-ISI Hirose Connector Interface Cable	\$ 115.38

**CONSULT TABLE OF CONTENTS FOR REPLACEMENT PARTS & ADDITIONAL EAR INSERT OPTIONS**  
**CONTACT FACTORY FOR ALL INTRINSICALLY SAFE APPROVED PRODUCTS**

# M/A Com

Jaguar 700P / P7100 / P7130 P7150 / P7170 / P5100 / P5130 / P5150

Assembled Connector



PART NUMBER	DESCRIPTION	SUGGESTED RESELL
-------------	-------------	---------------------

## SURVEILLANCE KITS

V1-10520	1 Wire Earphone Kit <b>Black (Receive only no transmit)</b>	\$ 66.20
V1-10521	1 Wire Earphone Kit <b>Beige (Receive only no transmit)</b>	\$ 66.20
V1-10523	2 Wire Palm Microphone Kit <b>Black</b>	\$ 117.44
V1-10522	2 Wire Palm Microphone Kit <b>Beige</b>	\$ 117.44
V1-10525	3 Wire Mini Lapel Microphone Kit <b>Black</b>	\$ 126.68
V1-10524	3 Wire Mini Lapel Microphone Kit <b>Beige</b>	\$ 126.68

## EAR INSERT OPTIONS

*Consult table of contents for additional Ear Insert Options*

C800947	Regular Clear Ear Tip	\$ 1.06
C100733	Noise Attenuating Plugs ( <b>NRR 25dB</b> )	\$ 2.33
C806573-LM	Flexible Open Ear Inserts Left, Medium	\$ 15.38
C806573-RM	Flexible Open Ear Inserts Right, Medium	\$ 15.38

## WIRELESS ACCESSORIES FOR USE WITH SURVEILLANCE KITS

V1-10610	Wireless Ear Receiver used with Flat Pack Inductor or Neckloop (Conventional Version)	\$ 202.44
V1-10611	Wireless Ear Receiver used with Flat Pack Inductor or Neckloop (Squelched Version)	\$ 260.86
V1-10471	Flat Pack Inductor with 2 prong jack for use with existing 2 & 3 Wire Kits	\$ 70.73
V1-10666	28" Universal neck loop	\$ 70.73
V1-10603	49" Universal neck loop	\$ 80.98
C819021	Replacement batteries (4) for Wireless Ear Receiver	\$ 11.26
C101114	Wax Trap (15) and Installation Tool (Replacement Part for Wireless Ear Receiver)	\$ 18.96

## HEADSETS

V4-EX2EJ1	Explorer, lightweight, flexible earloop, w/ boom mic, quick-disconnect acoustic tube & standard PTT	\$ 125.26
V4-10374	Breeze, lightweight, behind-the-head, single spkr with standard PTT	\$ 113.87
* V4-BA2EJ3B	Breeze, lightweight, behind-the-head, single spkr w/std. PTT & 2.5mm pigtail for remote PTT	\$ 121.86
V4-10315	Lightweight Single Speaker Padded Headband with no PTT	\$ 120.44
V4-HC2EJ1	Hurricane, lightweight, dual spkr, 21dB reduction, behind-the-head, with Std. PTT	\$ 245.98
*V4-10458	Hurricane, lightweight, dual spkr, 21dB reduction, behind-the-head, with Std. PTT & 2.5mm pigtail for remote PTT, coil cord from PTT to UDC	\$ 250.98
V4-NR2EJ1	Ranger Single Speaker behind-the-head with standard PTT	\$ 316.73
V4-10316	Over-the-head Dual Speaker Heavy Duty with standard PTT	\$ 255.46
V4-10317	Behind-the-Head Dual Speaker Heavy Duty with standard PTT	\$ 255.46
V4-10379	ClearTRAK Behind-the-Head Dual Speaker Extreme Noise with Earcup PTT	\$ 395.37

## \* REMOTE PTT ACCESSORIES FOR BREEZE AND HURRICANE HEADSETS WITH 2.5MM JACK

V1-10513	Ring PTT with 2.5mm right angle plug, 5' straight cable	\$ 25.63
V1-10519	80mm Round Body PTT with 2.5mm right angle plug, coil cord	\$ 96.77

## SPEAKER MICROPHONES

V2-10154	Evolution Speaker Mic with Coil cord, volume control, 2.5mm earphone jack and emergency button	\$ 117.41
V2-10155	Evolution Speaker Mic with Straight Coaxial cord, volume control, 2.5mm earphone jack, emergency button and antenna connector	\$ 147.34
V2-10156	Evolution Speaker Mic with Coiled Coaxial cord, volume control, 2.5mm earphone jack, antenna connector and emergency button	\$ 211.74
V2-G2EJ211	Genesis with Coil Cord	\$ 129.38
V2-G2EJ221	Genesis Coil Cord and Emergency Button	\$ 143.57
V2-G2EJ223	Genesis Straight Coax Cable, Antenna Connector & Emergency Button	\$ 172.77
V2-G2EJ222	Genesis Coiled Coax Cable, Antenna Connector & Emergency Button	\$ 235.60
V2-G2EJ321	Genesis Coil Cord, Emergency Button & Accessory Jack	\$ 158.57
V2-G2EJ323	Genesis Straight Coax Cable, Antenna Connector, Emergency Button & Accessory Jack	\$ 187.77
V2-G2EJ322	Genesis Coiled Coax Cable, Antenna Connector, Emergency Button & Accessory Jack	\$ 250.60



# M/A Com

Jaguar 700P / P7100 / P7130 P7150 / P7170 / P5100 / P5130 / P5150

PART NUMBER	DESCRIPTION	SUGGESTED RESALE
-------------	-------------	---------------------

### EARPHONE KITS FOR USE WITH EVOLUTION AND PROFILE SPEAKER MICROPHONES ONLY

V1-10282	2.5mm straight plug, coil cord (30" extended length), black	\$ 47.44
V1-10432	2.5mm right angle plug, coil cord (30" extended length), black	\$ 47.44
V1-EH22R131	2.5mm right angle plug, <b>Earhanger</b> , coil cord (30" extended length), black	\$ 26.93
V1-10305	3.5mm straight plug, coil cord (30" extended length), black	\$ 47.44
V1-10433	3.5mm right angle plug, coil cord (30" extended length) black	\$ 47.44

### ACCESSORIES FOR GENESIS WITH ACCESSORY JACK OPTION

V1-10750	Earphone with acoustic tube and Hirose Connector	\$ 91.78
V4-10478	Hurricane, lightweight, dual sprk, 21db reduction, behind-the-head with Hirose Connector	\$ 265.38
V1-10656	Throat Microphone with Hirose Connector	\$ 289.58
V4-10421	Ranger Single Speaker, behind-the-head, NO PTT with Hirose Connector	\$ 291.84
V4-10450	Behind-the-head Dual Speaker Heavy Duty with no PTT	\$ 306.24
V4-10428	Skull Microphone with Hirose Connector	\$ 318.81
V3-10301	SCBA-ISI Hirose Connector Interface Cable	\$ 115.38

### TACTICAL, FIRE, & HAZMAT COMMUNICATIONS EQUIPMENT

V1-T12EJ137	Throat Microphone with Acoustic Tube & 80 MM PTT	\$ 470.48
V1-T12EJ117	Throat Microphone with Acoustic Tube and Remote Ring PTT	\$ 526.85
V4-10380	Skull Microphone with Earcup & 80 MM PTT	\$ 562.73
V3-10340	Interface Cable for Viking Mask with 6 Pin Hirose	\$ 175.00

**CONSULT TABLE OF CONTENTS FOR REPLACEMENT PARTS & ADDITIONAL EAR INSERT OPTIONS**

**CONTACT FACTORY FOR ALL INTRINSICALLY SAFE APPROVED PRODUCTS**

# Maxon

SP120, SP130, SP140  
 SP300, SP310, SP320, SP330, SP340, SL55+ with adapter ACC-501

2.5/3.5mm Right Angle Plug



Adapter ACC-501 is available  
 through Maxon and/or Topaz3)

PART NUMBER	DESCRIPTION	SUGGESTED RESALE
-------------	-------------	---------------------

## SURVEILLANCE KITS

V1-10374	1 Wire Earphone Kit <b>Black (Receive only no transmit)</b>	\$ 55.01
V1-10373	1 Wire Earphone Kit <b>Beige (Receive only no transmit)</b>	\$ 55.01
V1-B22XB131	2 Wire Earbud <b>Black</b>	\$ 48.43
V1-10376	2 Wire Palm Microphone Kit <b>Black</b>	\$ 87.89
V1-10375	2 Wire Palm Microphone Kit <b>Beige</b>	\$ 87.89
V1-10378	3 Wire Mini Lapel Microphone Kit <b>Black</b>	\$ 162.96
V1-10377	3 Wire Mini Lapel Microphone Kit <b>Beige</b>	\$ 162.96

## EAR INSERT OPTIONS

*Consult table of contents for additional Ear Insert Options*

C800947	Regular Clear Ear Tip	\$ 1.06
C100733	Noise Attenuating Plugs ( <b>NRR 25dB</b> )	\$ 2.33
C806573-LM	Flexible Open Ear Inserts Left, Medium	\$ 15.38
C806573-RM	Flexible Open Ear Inserts Right, Medium	\$ 15.38

## WIRELESS ACCESSORIES FOR USE WITH SURVEILLANCE KITS

V1-10610	Wireless Ear Receiver used with Flat Pack Inductor or Neckloop (Conventional Version)	\$ 202.44
V1-10611	Wireless Ear Receiver used with Flat Pack Inductor or Neckloop (Squelched Version)	\$ 260.86
V1-10471	Flat Pack Inductor with 2 prong jack for use with existing 2 & 3 Wire Kits	\$ 70.73
V1-10666	28" Universal neck loop	\$ 70.73
V1-10603	49" Universal neck loop	\$ 80.98
C819021	Replacement batteries (4) for Wireless Ear Receiver	\$ 11.26
C101114	Wax Trap (15) and Installation Tool (Replacement Part for Wireless Ear Receiver)	\$ 18.96

## HEADSETS

V4-EX2XB5	Explorer, lightweight, flexible earloop, w/ boom mic, quick-disconnect acoustic tube, mini PTT	\$ 87.88
V4-BA2XB1	Breeze, lightweight, behind-the-head, single spkr with standard PTT	\$ 77.66
V4-10095	Lightweight Single Speaker Padded Headband with standard PTT	\$ 102.15
V4-10097	Over-the-head Dual Speaker Heavy Duty with standard PTT	\$ 282.87
V4-10098	Behind-the-Head Dual Speaker Heavy Duty with standard PTT	\$ 331.76
V4-10368	ClearTRAK Behind-the-Head Dual Speaker Extreme Noise with Earcup PTT	\$ 395.37

## SPEAKER MICROPHONES

*No Adapter Required*

V2-L2XB11	Profile Speaker Microphone with 2.5mm earphone jack ( <b>For SP-120/130/140 Only</b> )	\$ 66.24
V2-10071	Evolution Speaker Mic with Coil cord, volume control and 2.5mm earphone jack ( <b>For SP-120/130/140 Only</b> )	\$ 89.18

## EARPHONE KITS FOR USE WITH EVOLUTION AND PROFILE REMOTE SPEAKER MICROPHONES ONLY

V1-10282	2.5mm straight plug, coil cord (30" extended length), black	\$ 47.44
V1-10432	2.5mm right angle plug, coil cord (30" extended length), black	\$ 47.44
V1-EH22R131	2.5mm right angle plug, <b>Earhanger</b> , coil cord (30" extended length), black	\$ 26.93
V1-10305	3.5mm straight plug, coil cord (30" extended length), black	\$ 47.44
V1-10433	3.5mm right angle plug, coil cord (30" extended length) black	\$ 47.44

**CONSULT TABLE OF CONTENTS FOR REPLACEMENT PARTS & ADDITIONAL EAR INSERT OPTIONS**

**CONTACT FACTORY FOR ALL INTRINSICALLY SAFE APPROVED PRODUCTS**

# Maxon

SP200, SP200K, SP210, SL100 and Legacy Series-PL1145, PL2245, PL2215P, PL2245P, PL2415, PL2445, PL5161, PL5164



3.5MM Right Angle Connector with 1 Locking Screw

PART NUMBER	DESCRIPTION	SUGGESTED RESALE
-------------	-------------	---------------------

## SURVEILLANCE KITS

V1-10733	1 Wire Earphone Kit <b>Black (Receive only no transmit)</b>	\$ 55.01
V1-B22XD131	2 Wire Earbud <b>Black</b>	\$ 48.43
V1-10732	2 Wire Palm Microphone Kit <b>Black</b>	\$ 87.89

## EAR INSERT OPTIONS

*Consult table of contents for additional Ear Insert Options*

C800947	Regular Clear Ear Tip	\$ 1.06
C100733	Noise Attenuating Plugs ( <b>NRR 25dB</b> )	\$ 2.33
C806573-LM	Flexible Open Ear Inserts Left, Medium	\$ 15.38
C806573-RM	Flexible Open Ear Inserts Right, Medium	\$ 15.38

## WIRELESS ACCESSORIES FOR USE WITH SURVEILLANCE KITS

V1-10610	Wireless Ear Receiver used with Flat Pack Inductor or Neckloop (Conventional Version)	\$ 202.44
V1-10611	Wireless Ear Receiver used with Flat Pack Inductor or Neckloop (Squelched Version)	\$ 260.86
V1-10471	Flat Pack Inductor with 2 prong jack for use with existing 2 & 3 Wire Kits	\$ 70.73
V1-10666	28" Universal neck loop	\$ 70.73
V1-10603	49" Universal neck loop	\$ 80.98
C819021	Replacement batteries (4) for Wireless Ear Receiver	\$ 11.26
C101114	Wax Trap (15) and Installation Tool (Replacement Part for Wireless Ear Receiver)	\$ 18.96

## HEADSETS

V4-EX2XD2	Explorer, lightweight, flexible earloop w/boom mic, quick-disconnect acoustic tube, no PTT	\$ 68.52
V4-EX2XD5	Explorer, lightweight, flexible earloop, w/ boom mic, quick-disconnect acoustic tube, mini PTT	\$ 87.88
V4-BA2XD2	Breeze, lightweight, behind-the-head, single spkr, no PTT	\$ 47.68
V4-BA2XD5	Breeze, lightweight, behind-the-head, single spkr, with mini PTT	\$ 56.76
V4-10462	Lightweight Single Speaker Padded Headband no PTT	\$ 75.17

## SPEAKER MICROPHONES

V2-L2XD11	Profile Speaker Microphone with 2.5mm earphone jack	\$ 66.24
V2-10157	Evolution Speaker Mic with Coil cord, volume control and 2.5mm earphone jack	\$ 89.18

## EARPHONE KITS FOR USE WITH EVOLUTION AND PROFILE REMOTE SPEAKER MICROPHONES ONLY

V1-10282	2.5mm straight plug, coil cord (30" extended length), black	\$ 47.44
V1-10432	2.5mm right angle plug, coil cord (30" extended length), black	\$ 47.44
V1-EH22R131	2.5mm right angle plug, <b>Earhanger</b> , coil cord (30" extended length), black	\$ 26.93
V1-10305	3.5mm straight plug, coil cord (30" extended length), black	\$ 47.44
V1-10433	3.5mm right angle plug, coil cord (30" extended length) black	\$ 47.44

**CONSULT TABLE OF CONTENTS FOR REPLACEMENT PARTS & ADDITIONAL EAR INSERT OPTIONS**

**CONTACT FACTORY FOR ALL INTRINSICALLY SAFE APPROVED PRODUCTS**

# Maxon

SP-2550/SP-2850,SL70W Series, EP-4800,TP4800,TP4801

6 pin Hirose Connector



PART NUMBER	DESCRIPTION	SUGGESTED RESALE
-------------	-------------	---------------------

## SURVEILLANCE KITS

*Earphone kit is not compatible with these portable radios due to radio circuitry.*

V1-10155	2 Wire Palm Microphone Kit <b>Black</b>	\$ 109.20
V1-10157	2 Wire Palm Microphone Kit <b>Beige</b>	\$ 109.20
V1-10159	3 Wire Mini Lapel Microphone Kit <b>Black</b>	\$ 121.06
V1-10160	3 Wire Mini Lapel Microphone Kit <b>Beige</b>	\$ 121.06

## EAR INSERT OPTIONS Consult table of contents for additional Ear Insert Options

C800947	Regular Clear Ear Tip	\$ 1.06
C100733	Noise Attenuating Plugs ( <b>NRR 25dB</b> )	\$ 2.33
C806573-LM	Flexible Open Ear Inserts Left, Medium	\$ 15.38
C806573-RM	Flexible Open Ear Inserts Right, Medium	\$ 15.38

## WIRELESS ACCESSORIES FOR USE WITH SURVEILLANCE KITS

V1-10610	Wireless Ear Receiver used with Flat Pack Inductor or Neckloop (Conventional Version)	\$ 202.44
V1-10611	Wireless Ear Receiver used with Flat Pack Inductor or Neckloop (Squelched Version)	\$ 260.86
V1-10471	Flat Pack Inductor with 2 prong jack for use with existing 2 & 3 Wire Kits	\$ 70.73
V1-10666	28" Universal neck loop	\$ 70.73
V1-10603	49" Universal neck loop	\$ 80.98
C819021	Replacement batteries (4) for Wireless Ear Receiver	\$ 11.26
C101114	Wax Trap (15) and Installation Tool (Replacement Part for Wireless Ear Receiver)	\$ 18.96

## HEADSETS

V4-BA2EX2	Breeze, lightweight, behind-the-head, single spkr, no PTT	\$ 65.64
V4-BA2EX1	Breeze, lightweight, behind-the-head, single spkr with standard PTT	\$ 84.20
* V4-BA2EX3B	Breeze, lightweight, behind-the-head, single spkr w/std. PTT & 2.5mm pigtail for remote PTT	\$ 91.38
V4-10184	Lightweight Single Speaker Padded Headband with no PTT	\$ 88.97
V4-10188	Over-the-head Dual Speaker Heavy Duty with standard PTT	\$ 297.12
V4-10008	Behind-the-Head Dual Speaker Heavy Duty with standard PTT	\$ 382.48

## \* REMOTE PTT ACCESSORIES FOR BREEZE HEADSETS WITH 2.5MM JACK

V1-10513	Ring PTT with 2.5mm right angle plug, 5' straight cable	\$ 25.63
V1-10519	80mm Round Body PTT with 2.5mm right angle plug, coil cord	\$ 96.77

## SPEAKER MICROPHONES

V2-L2XA11	Profile Speaker Microphone with 2.5mm earphone jack	\$ 78.74
V2-10032	Evolution Speaker Mic with Coil cord, volume control and 2.5mm earphone jack	\$ 96.07

## EARPHONE KITS FOR USE WITH EVOLUTION AND PROFILE REMOTE SPEAKER MICROPHONES ONLY

V1-10282	2.5mm straight plug, coil cord (30" extended length), black	\$ 47.44
V1-10432	2.5mm right angle plug, coil cord (30" extended length), black	\$ 47.44
V1-EH22R131	2.5mm right angle plug, <b>Earhanger</b> , coil cord (30" extended length), black	\$ 26.93
V1-10305	3.5mm straight plug, coil cord (30" extended length), black	\$ 47.44
V1-10433	3.5mm right angle plug, coil cord (30" extended length) black	\$ 47.44

CONSULT TABLE OF CONTENTS FOR REPLACEMENT PARTS & ADDITIONAL EAR INSERT OPTIONS

CONTACT FACTORY FOR ALL INTRINSICALLY SAFE APPROVED PRODUCTS

# Motorola

## Spirit GT / Spirit GT+

Single Pin Right Angle Connector



PART NUMBER	DESCRIPTION	SUGGESTED RESALE
-------------	-------------	---------------------

### SURVEILLANCE KITS

V1-10192	2 Wire Palm Microphone Kit <b>Black</b>	\$ 95.38
V1-10699	2 Wire Palm Microphone Kit <b>Beige</b>	\$ 95.38

### EAR INSERT OPTIONS *Consult table of contents for additional Ear Insert Options*

C800947	Regular Clear Ear Tip	\$ 1.06
C100733	Noise Attenuating Plugs ( <b>NRR 25dB</b> )	\$ 2.33
C806573-LM	Flexible Open Ear Inserts Left, Medium	\$ 15.38
C806573-RM	Flexible Open Ear Inserts Right, Medium	\$ 15.38

### HEADSETS

V4-BA2MP2	Breeze, lightweight, behind-the-head, single spkr, no PTT	\$ 44.62
V4-BA2MP5	Breeze, lightweight, behind-the-head, single spkr, with mini PTT	\$ 52.30
V4-EX2MP2	Explorer, lightweight, flexible earloop w/boom mic, quick-disconnect acoustic tube, no PTT	\$ 52.30
V4-EX2MP5	Explorer, lightweight, flexible earloop, w/ boom mic, quick-disconnect acoustic tube, mini PTT	\$ 66.07

**CONSULT TABLE OF CONTENTS FOR REPLACEMENT PARTS & ADDITIONAL EAR INSERT OPTIONS**  
**CONTACT FACTORY FOR ALL INTRINSICALLY SAFE APPROVED PRODUCTS**

## Motorola

SP10, SP21, XTN500, XTN600, PRO1150, PRO2150, CP100, PMR446, XTN446, XU1100, CLS1110, CLS1410, XU2600, PR400

2.5mm/3.5mm Right Angle Connector



PART NUMBER	DESCRIPTION	SUGGESTED RESALE
-------------	-------------	---------------------

## SURVEILLANCE KITS

V1-10182	1 Wire Earphone Kit <b>Black (Receive only no transmit)</b>	\$ 40.71
V1-10181	1 Wire Earphone Kit <b>Beige (Receive only no transmit)</b>	\$ 40.71
V1-B22ME131	2 Wire Earbud <b>Black</b>	\$ 42.69
V1-10180	2 Wire Palm Microphone Kit <b>Black</b>	\$ 81.19
V1-10179	2 Wire Palm Microphone Kit <b>Beige</b>	\$ 81.19

EAR INSERT OPTIONS *Consult table of contents for additional Ear Insert Options*

C800947	Regular Clear Ear Tip	\$ 1.06
C100733	Noise Attenuating Plugs (NRR 25dB)	\$ 2.33
C806573-LM	Flexible Open Ear Inserts Left, Medium	\$ 15.38
C806573-RM	Flexible Open Ear Inserts Right, Medium	\$ 15.38

## WIRELESS ACCESSORIES FOR USE WITH SURVEILLANCE KITS

V1-10610	Wireless Ear Receiver used with Flat Pack Inductor or Neckloop (Conventional Version)	\$ 202.44
V1-10611	Wireless Ear Receiver used with Flat Pack Inductor or Neckloop (Squelched Version)	\$ 260.86
V1-10471	Flat Pack Inductor with 2 prong jack for use with existing 2 & 3 Wire Kits	\$ 70.73
V1-10666	28" Universal neck loop	\$ 70.73
V1-10603	49" Universal neck loop	\$ 80.98
C819021	Replacement batteries (4) for Wireless Ear Receiver	\$ 11.26
C101114	Wax Trap (15) and Installation Tool (Replacement Part for Wireless Ear Receiver)	\$ 18.96

## HEADSETS

V4-EX2ME2	Explorer, lightweight, flexible earloop w/boom mic, quick-disconnect acoustic tube, no PTT	\$ 57.14
V4-EX2ME5	Explorer, lightweight, flexible earloop, w/ boom mic, quick-disconnect acoustic tube, mini PTT	\$ 73.13
V4-BA2ME2	Breeze, lightweight, behind-the-head, single spkr, no PTT	\$ 47.68
V4-BA2ME5	Breeze, lightweight, behind-the-head, single spkr, with mini PTT	\$ 56.76
V4-BA2ME1	Breeze, lightweight, behind-the-head, single spkr with standard PTT	\$ 77.66
V4-BH2ME2	Breeze, lightweight, behind-the-head, <b>adjustable headband</b> , single spkr, no PTT	\$ 52.63
V4-BH2ME5	Breeze, lightweight, behind-the-head, <b>adjustable headband</b> , single spkr, mini PTT	\$ 61.71
V4-10193	Lightweight Single Speaker Padded Headband no PTT	\$ 72.17
V4-HC2ME2	Hurricane, lightweight, dual spkr, 21dB reduction, behind-the-head, no PTT	\$ 204.67
V4-HC2ME5	Hurricane, lightweight, dual spkr, 21dB reduction, behind-the-head, with mini PTT	\$ 224.98
V4-10147	Over-the-head Dual Speaker Heavy Duty with standard PTT	\$ 251.44
V4-10004	Behind-the-Head Dual Speaker Heavy Duty with standard PTT	\$ 341.08

## SPEAKER MICROPHONES

V2-C2ME11	Legacy Speaker Microphone with 2.5mm earphone jack	\$ 37.44
V2-L2ME11	Profile Speaker Microphone with 2.5mm earphone jack	\$ 61.15

## EARPHONE KITS FOR USE WITH EVOLUTION AND PROFILE REMOTE SPEAKER MICROPHONES ONLY

V1-10282	2.5mm straight plug, coil cord (30" extended length), black	\$ 47.44
V1-10432	2.5mm right angle plug, coil cord (30" extended length), black	\$ 47.44
V1-EH22R131	2.5mm right angle plug, <b>Earhanger</b> , coil cord (30" extended length), black	\$ 26.93
V1-10305	3.5mm straight plug, coil cord (30" extended length), black	\$ 47.44
V1-10433	3.5mm right angle plug, coil cord (30" extended length) black	\$ 47.44

## EARPHONE KIT FOR USE WITH LEGACY SPEAKER MICROPHONE ONLY

V1-10598	2.5mm straight plug Coil Cord (12" length), black	\$ 29.95
----------	---	----------

CONSULT TABLE OF CONTENTS FOR REPLACEMENT PARTS &amp; ADDITIONAL EAR INSERT OPTIONS

CONTACT FACTORY FOR ALL INTRINSICALLY SAFE APPROVED PRODUCTS

**Motorola**  
 GP300,SP50,P110,  
 P1225/P1225LS,P200, LTS2000,CP88, CP150, CP200  
 CT150,CT250,CT450, CT450LS,GP308,P080,P2000, PRO3150, P040, P080, GP68, GP88,  
 GTX (Headsets with PTT only)  
 GP350 (With Motorola adapter HLN9482)

2.5mm/3.5mm Right Angle Connector



PART NUMBER	DESCRIPTION	SUGGESTED RESALE
-------------	-------------	---------------------

**SURVEILLANCE KITS**

V1-10178	1 Wire Earphone Kit <b>Black (Receive only no transmit)</b>	\$ 36.92
V1-10177	1 Wire Earphone Kit <b>Beige (Receive only no transmit)</b>	\$ 36.92
V1-B22MG131	2 Wire Earbud <b>Black</b>	\$ 48.43
V1-10176	2 Wire Palm Microphone Kit <b>Black</b>	\$ 105.66
V1-10175	2 Wire Palm Microphone Kit <b>Beige</b>	\$ 105.66
V1-10338	2 Wire Field <b>Repairable</b> Palm Microphone Kit, <b>Black</b>	\$ 113.66
V1-10284	3 Wire Mini Lapel Microphone Kit <b>Black</b>	\$ 118.37
V1-10283	3 Wire Mini Lapel Microphone Kit <b>Beige</b>	\$ 118.37

**EAR INSERT OPTIONS** Consult table of contents for additional Ear Insert Options

C800947	Regular Clear Ear Tip	\$ 1.06
C100733	Noise Attenuating Plugs ( <b>NRR 25dB</b> )	\$ 2.33
C806573-LM	Flexible Open Ear Inserts Left, Medium	\$ 15.38
C806573-RM	Flexible Open Ear Inserts Right, Medium	\$ 15.38

**WIRELESS ACCESSORIES FOR USE WITH SURVEILLANCE KITS**

V1-10610	Wireless Ear Receiver used with Flat Pack Inductor or Neckloop (Conventional Version)	\$ 202.44
V1-10611	Wireless Ear Receiver used with Flat Pack Inductor or Neckloop (Squelched Version)	\$ 260.86
V1-10471	Flat Pack Inductor with 2 prong jack for use with existing 2 & 3 Wire Kits	\$ 70.73
V1-10666	28" Universal neck loop	\$ 70.73
V1-10603	49" Universal neck loop	\$ 80.98
C819021	Replacement batteries (4) for Wireless Ear Receiver	\$ 11.26
C101114	Wax Trap (15) and Installation Tool (Replacement Part for Wireless Ear Receiver)	\$ 18.96

**HEADSETS**

V4-EX2MG2	Explorer, lightweight, flexible earloop w/boom mic, quick-disconnect acoustice tube, no PTT	\$ 58.43
V4-EX2MG5	Explorer, lightweight, flexible earloop, w/ boom mic, quick-disconnect acoustic tube, mini PTT	\$ 74.19
V4-BA2MG2	Breeze, lightweight, behind-the-head, single spkr, no PTT	\$ 47.68
V4-BA2MG5	Breeze, lightweight, behind-the-head, single spkr, with mini PTT	\$ 56.76
V4-BA2MG1	Breeze, lightweight, behind-the-head, single spkr with standard PTT	\$ 77.66
* V4-BA2MG3B	Breeze, lightweight, behind-the-head, single spkr w/std. PTT & 2.5mm pigtail for remote PTT	\$ 86.06
V4-BH2MG2	Breeze, lightweight, behind-the-head, <b>adjustable headband</b> , single spkr, no PTT	\$ 52.63
V4-BH2MG5	Breeze, lightweight, behind-the-head, <b>adjustable headband</b> , single spkr, mini PTT	\$ 61.71
V4-10192	Lightweight Single Speaker Padded Headband no PTT	\$ 72.17
V4-10053	Lightweight Single Speaker Padded Headband with standard PTT	\$ 113.86
V4-HC2MG2	Hurricane, lightweight, dual spkr, 21dB reduction,behind-the-head, no PTT	\$ 199.67
V4-HC2MG5	Hurricane, lightweight, dual spkr, 21dB reduction,behind-the-head,with mini PTT	\$ 234.67
* V4-HC2MG3B	Hurricane, lightweight, dual spkr, 21dB reduction,behind-the-head, w/std. PTT & 2.5mm pigtail for remote PTT	\$ 250.00
V4-HE2MG5	Hurricane with Extreme Noise Canceling mic, lightweight, dual spkr, 21dB reduction, behind-the-head, and mini PTT	\$ 254.67
V4-HE2MG3B	Hurricane with Extreme Noise Canceling mic, lightweight, dual spkr, 21dB reduction, behind-the-head, w Std. PTT & 2.5mm pigtail fro remote PTT	\$ 269.67
V4-NR2MG1	Ranger Single Speaker behind-the-head with standard PTT	\$ 306.48
V4-10146	Over-the-head Dual Speaker Heavy Duty with standard PTT	\$ 239.70
V4-10003	Behind-the-Head Dual Speaker Heavy Duty with standard PTT	\$ 299.62
V4-10390	ClearTRAK Over-the-Head Dual Speaker Extreme Noise with Earcup PTT	\$ 318.52
V4-10047	ClearTRAK Behind-the-Head Dual Speaker Extreme Noise with Earcup PTT	\$ 378.34

continued on page 40

## Motorola

GP300,SP50,P110,  
P1225/P1225LS,P200, LTS2000,CP88, CP150, CP200  
CT150,CT250,CT450, CT450LS,GP308,P080,P2000, PRO3150, P040, P080, GP68, GP88,  
GTX (Headsets with PTT only)  
GP350 (With Motorola adapter HLN9482)

PART NUMBER	DESCRIPTION	SUGGESTED RESALE
-------------	-------------	---------------------

### \* REMOTE PTT ACCESSORIES FOR BREEZE, HURRICANE AND RANGER HEADSETS WITH 2.5MM JACK

V1-10513	Ring PTT with 2.5mm right angle plug, 5' straight cable	\$ 25.63
V1-10519	80mm Round Body PTT with 2.5mm right angle plug, coil cord	\$ 96.77

### SPEAKER MICROPHONES

V2-C2MG11	Legacy Speaker Microphone with 2.5mm earphone jack	\$ 37.44
V2-L2MG11	Profile Speaker Microphone with 2.5mm earphone jack	\$ 66.24
V2-10026	Evolution Speaker Mic with Coil cord, volume control and 2.5mm earphone jack	\$ 78.69
V2-10220	Evolution H20 Immersion Rated (IP68), with Coil Cord, volume control	\$ 108.81
V2-G2MG211	Genesis with Coil Cord	\$ 115.17

### EARPHONE KITS FOR USE WITH EVOLUTION AND PROFILE REMOTE SPEAKER MICROPHONES ONLY

V1-10282	2.5mm straight plug, coil cord (30" extended length), black	\$ 47.44
V1-10432	2.5mm right angle plug, coil cord (30" extended length), black	\$ 47.44
V1-EH22R131	2.5mm right angle plug, <b>Earhanger</b> , coil cord (30" extended length), black	\$ 26.93
V1-10305	3.5mm straight plug, coil cord (30" extended length), black	\$ 47.44
V1-10433	3.5mm right angle plug, coil cord (30" extended length) black	\$ 47.44

### EARPHONE KIT FOR USE WITH LEGACY SPEAKER MICROPHONE ONLY

V1-10598	2.5mm straight plug Coil Cord (12" length), black	\$ 29.95
----------	---	----------

### TACTICAL, FIRE, & HAZMAT COMMUNICATIONS EQUIPMENT

V1-T12MG137	Throat Microphone with Acoustic Tube & 80 MM PTT	\$ 439.73
-------------	--	-----------

**CONSULT TABLE OF CONTENTS FOR REPLACEMENT PARTS & ADDITIONAL EAR INSERT OPTIONS**

**CONTACT FACTORY FOR ALL INTRINSICALLY SAFE APPROVED PRODUCTS**



**Motorola  
EX500/EX600, GL200  
GP344/GP388**

Assembled Connector



MOTOROLA

PART NUMBER	DESCRIPTION	SUGGESTED RESALE
-------------	-------------	---------------------

**SURVEILLANCE KITS**

V1-10774	1 Wire Earphone Kit <b>Black (Receive only no transmit)</b>	\$ 41.94
V1-10775	1 Wire Earphone Kit <b>Beige (Receive only no transmit)</b>	\$ 41.94
V1-10778	2 Wire Palm Microphone Kit <b>Black</b>	\$ 104.87
V1-10776	2 Wire Palm Microphone Kit <b>Beige</b>	\$ 104.87
V1-10779	3 Wire Mini Lapel Microphone Kit w/ Ring PTT <b>Black</b>	\$ 134.83

**EAR INSERT OPTIONS** *Consult table of contents for additional Ear Insert Options*

C800947	Regular Clear Ear Tip	\$ 1.06
C100733	Noise Attenuating Plugs ( <b>NRR 25dB</b> )	\$ 2.33
C806573-LM	Flexible Open Ear Inserts Left, Medium	\$ 15.38
C806573-RM	Flexible Open Ear Inserts Right, Medium	\$ 15.38

**WIRELESS ACCESSORIES FOR USE WITH SURVEILLANCE KITS**

V1-10610	Wireless Ear Receiver used with Flat Pack Inductor or Neckloop (Conventional Version)	\$ 202.44
V1-10611	Wireless Ear Receiver used with Flat Pack Inductor or Neckloop (Squelched Version)	\$ 260.86
V1-10471	Flat Pack Inductor with 2 prong jack for use with existing 2 & 3 Wire Kits	\$ 70.73
V1-10666	28" Universal neck loop	\$ 70.73
V1-10603	49" Universal neck loop	\$ 80.98
C819021	Replacement batteries (4) for Wireless Ear Receiver	\$ 11.26
C101114	Wax Trap (15) and Installation Tool (Replacement Part for Wireless Ear Receiver)	\$ 18.96

**HEADSETS**

V4-EX2MM5	Explorer, lightweight, flexible earloop, w/ boom mic, quick-disconnect acoustic tube, mini PTT	\$ 69.70
V4-BA2MM5	Breeze, lightweight, behind-the-head, single spkr with standard PTT	\$ 56.76
V4-BA2MM3B	Breeze, lightweight, behind-the-head, single spkr w/std. PTT & 2.5mm pigtail for remote PTT	\$ 86.06
V4-10494	Lightweight Single Speaker Padded Headband with standard PTT	\$ 124.87
V4-HC2MM5	Hurricane, lightweight, dual spkr, 21dB reduction, behind-the-head, with mini PTT	\$ 250.58
V4-NR2MM1	Ranger Single Speaker behind-the-head with standard PTT	\$ 337.07

**SPEAKER MICROPHONES**

V2-L2MM11	Profile Speaker Microphone with 2.5mm earphone jack	\$ 69.29
V2-10295	Evolution Speaker Mic with Coil cord, volume control and 2.5mm earphone jack	\$ 90.88

**EARPHONE KITS FOR USE WITH EVOLUTION AND PROFILE REMOTE SPEAKER MICROPHONES ONLY**

V1-10282	2.5mm straight plug, coil cord (30" extended length), black	\$ 47.44
V1-10432	2.5mm right angle plug, coil cord (30" extended length), black	\$ 47.44
V1-EH22R131	2.5mm right angle plug, <b>Earhanger</b> , coil cord (30" extended length), black	\$ 26.93
V1-10433	3.5mm right angle plug, coil cord (30" extended length) black	\$ 47.44
V1-10305	3.5mm straight plug, coil cord (30" extended length), black	\$ 47.44

**CONSULT TABLE OF CONTENTS FOR REPLACEMENT PARTS & ADDITIONAL EAR INSERT OPTIONS  
CONTACT FACTORY FOR ALL INTRINSICALLY SAFE APPROVED PRODUCTS**

# Motorola

HT750, HT1250, HT1250LS, HT1550/HT1550XLS, MTX850/MTX850LS, MTX8250/MTX8250LS, MTX950/MTX9250  
GP140,GP320,GP328,GP338,GP340,GP360,GP380,GP640,GP680,GP1280,PRO5150,PRO7150,PRO9150,PR860

Assembled Connector



PART NUMBER	DESCRIPTION	SUGGESTED RESALE
-------------	-------------	---------------------

## SURVEILLANCE KITS

V1-10673	1 Wire Earphone Kit <b>Black (Receive only no transmit)</b>	\$ 41.94
V1-10674	1 Wire Earphone Kit <b>Beige (Receive only no transmit)</b>	\$ 41.94
V1-10669	2 Wire Palm Microphone Kit <b>Black</b>	\$ 104.87
V1-10670	2 Wire Palm Microphone Kit <b>Beige</b>	\$ 104.87
V1-10710	3 Wire Mini Lapel Microphone Kit w/ Ring PTT <b>Black</b>	\$ 134.83
V1-10709	3 Wire Mini Lapel Microphone Kit w/ <b>Black</b> Ring PTT <b>Beige</b>	\$ 134.83
V1-10686*	3 Wire Mini Lapel Microphone Kit w/ Hardwired Inductive Neck Loop <b>Beige</b>	\$ 189.63
	* 3 Wire Kit will only function when used with Wireless Ear Receiver	

## EAR INSERT OPTIONS

Consult table of contents for additional Ear Insert Options

C800947	Regular Clear Ear Tip	\$ 1.06
C100733	Noise Attenuating Plugs ( <b>NRR 25dB</b> )	\$ 2.33
C806573-LM	Flexible Open Ear Inserts Left, Medium	\$ 15.38
C806573-RM	Flexible Open Ear Inserts Right, Medium	\$ 15.38

## WIRELESS ACCESSORIES FOR USE WITH SURVEILLANCE KITS

V1-10610	Wireless Ear Receiver used with Flat Pack Inductor or Neckloop (Conventional Version)	\$ 202.44
V1-10611	Wireless Ear Receiver used with Flat Pack Inductor or Neckloop (Squelched Version)	\$ 260.86
V1-10471	Flat Pack Inductor with 2 prong jack for use with existing 2 & 3 Wire Kits	\$ 70.73
V1-10666	28" Universal neck loop	\$ 70.73
V1-10603	49" Universal neck loop	\$ 80.98
C819021	Replacement batteries (4) for Wireless Ear Receiver	\$ 11.26
C101114	Wax Trap (15) and Installation Tool (Replacement Part for Wireless Ear Receiver)	\$ 18.96

## HEADSETS

V4-EX2MJ2	Explorer, lightweight, flexible earloop w/boom mic, quick-disconnect acoustic tube, no PTT	\$ 58.43
V4-EX2MJ5	Explorer, lightweight, flexible earloop, w/ boom mic, quick-disconnect acoustic tube, mini PTT	\$ 69.70
V4-10433	Lightweight Single Speaker Padded Headband no PTT	\$ 104.87
V4-HC2MJ5	Hurricane, lightweight, dual spkr, 21dB reduction, behind-the-head, with mini PTT	\$ 250.58
* V4-HC2MJ3B	Hurricane, lightweight, dual spkr, 21dB reduction, behind-the-head, w/std. PTT & 2.5mm pigtail for remote PTT	\$ 266.00
V4-HE2MJ5	Hurricane with Extreme Noise Canceling mic, lightweight, dual spkr, 21dB reduction, behind-the-head and mini PTT	\$ 270.58
V4-HE2MJ3B	Hurricane with Extreme Noise Canceling mic, lightweight, dual spkr, 21dB reduction, behind-the-head, w Std. PTT & 2.5mm pigtail fro remote PTT	\$ 285.58
V4-NR2MJ1	Ranger Single Speaker behind-the-head with standard PTT	\$ 337.07
V4-10434	Over-the-head Dual Speaker Heavy Duty with no PTT	\$ 254.67
V4-10430	Over-the-head Dual Speaker Heavy Duty with standard PTT	\$ 277.60
V4-10431	Behind-the-Head Dual Speaker Heavy Duty with standard PTT	\$ 299.62

## \* REMOTE PTT ACCESSORIES FOR HURRICANE HEADSETS WITH 2.5MM JACK

V1-10513	Ring PTT with 2.5mm right angle plug, 5' straight cable	\$ 25.63
V1-10519	80mm Round Body PTT with 2.5mm right angle plug, coil cord	\$ 96.77

## SPEAKER MICROPHONES

V2-L2MJ11	Profile Speaker Microphone with 2.5mm earphone jack	\$ 69.29
V2-10228	Evolution Speaker Mic with Coil cord, volume control and 2.5mm earphone jack	\$ 90.88
V2-10230	Evolution H20 Immersion Rated (IP68), with Coil Cord, volume control	\$ 111.38
V2-G2MJ211	Genesis with Coil Cord	\$ 117.69
V2-G2MJ311	Genesis with Coil Cord & Accessory Jack	\$ 129.20

## EARPHONE KITS FOR USE WITH EVOLUTION AND PROFILE REMOTE SPEAKER MICROPHONES ONLY

V1-10282	2.5mm straight plug, coil cord (30" extended length), black	\$ 47.44
V1-10432	2.5mm right angle plug, coil cord (30" extended length), black	\$ 47.44
V1-EH22R131	2.5mm right angle plug, <b>Earhanger</b> , coil cord (30" extended length), black	\$ 26.93
V1-10305	3.5mm straight plug, coil cord (30" extended length), black	\$ 47.44
V1-10433	3.5mm right angle plug, coil cord (30" extended length) black	\$ 47.44

# Motorola

HT750, HT1250, HT1250LS, HT1550/HT1550XLS, MTX850/MTX850LS, MTX8250/MTX8250LS, MTX950/MTX9250  
 GP140,GP320,GP328,GP338,GP340,GP360,GP380,GP640,GP680,GP1280,PRO5150,PRO7150,PRO9150,PR860

PART NUMBER	DESCRIPTION	SUGGESTED RESALE
-------------	-------------	---------------------

### ACCESSORIES FOR GENESIS WITH ACCESSORY JACK OPTION

V1-10750	Earphone with acoustic tube and Hirose Connector	\$ 91.78
V4-10478	Hurricane, lightweight, dual sprk, 21db reduction, behind-the-head with Hirose Connector	\$ 265.38
V1-10656	Throat Microphone with Hirose Connector	\$ 289.58
V4-10421	Ranger Single Speaker, behind-the-head, no PTT with Hirose Connector	\$ 291.84
V4-10450	Behind-the-head Dual Speaker Heavy Duty with no PTT	\$ 306.24
V4-10428	Skull Microphone with Hirose Connector	\$ 318.81
V3-10301	SCBA-ISI Hirose Connector Interface Cable	\$ 115.38

### TACTICAL, FIRE, & HAZMAT COMMUNICATIONS EQUIPMENT

V1-T12MJ137	Throat Microphone with Acoustic Tube & 80 MM PTT	\$ 461.25
V1-T12MJ117	Throat Microphone with Acoustic Tube, 80 MM PTT and Remote Ring PTT	\$ 517.62
V4-10432	Skull Microphone with Earcup & 80 MM PTT	\$ 562.73
V3-10341	SCBA-ISI Hirose Connector Interface Cable	\$ 175.00

**CONSULT TABLE OF CONTENTS FOR REPLACEMENT PARTS & ADDITIONAL EAR INSERT OPTIONS**

**CONTACT FACTORY FOR ALL INTRINSICALLY SAFE APPROVED PRODUCTS**

# Motorola

XTS3000/Astro, XTS3500, XTS1500/2500/5000, HT1000, MT2000, MTS2000, MTX8000, MTX838, MTX1000, MTX9000, MTX-LS, JT1000, GP900 W/Adapter V1-10335, PR1500

Visar (No adapter required)

3.5mm Threaded plug (Requires adapter)



Adapter V1-10335

Assembled connector (No adapter required)



PART NUMBER	DESCRIPTION	SUGGESTED RESALE
-------------	-------------	---------------------

<b>SURVEILLANCE KITS</b> <i>Requires Adapter V1-10335</i>		
V1-10174	1 Wire Earphone Kit <b>Black (Receive only no transmit)</b>	\$ 42.30
V1-10173	1 Wire Earphone Kit <b>Beige (Receive only no transmit)</b>	\$ 42.30
V1-B22MA131	2 Wire Earbud <b>Black</b>	\$ 48.43
V1-10172	2 Wire Palm Microphone Kit <b>Black</b>	\$ 119.84
V1-10171	2 Wire Palm Microphone Kit <b>Beige</b>	\$ 119.84
V1-10337	2 Wire Field <b>Repairable</b> Palm Microphone Kit <b>Black</b>	\$ 156.07
V1-10170	3 Wire Mini Lapel Microphone Kit <b>Black</b>	\$ 136.54
V1-10169	3 Wire Mini Lapel Microphone Kit <b>Beige</b>	\$ 136.54
<b>V1-10335</b>	<b>Adapter required with use of above Surveillance Kits</b>	\$ 51.25

<b>EAR INSERT OPTIONS</b> <i>Consult table of contents for additional Ear Insert Options</i>		
C800947	Regular Clear Ear Tip	\$ 1.06
C100733	Noise Attenuating Plugs ( <b>NRR 25dB</b> )	\$ 2.33
C806573-LM	Flexible Open Ear Inserts Left, Medium	\$ 15.38
C806573-RM	Flexible Open Ear Inserts Right, Medium	\$ 15.38

<b>WIRELESS ACCESSORIES FOR USE WITH SURVEILLANCE KITS</b>		
V1-10610	Wireless Ear Receiver used with Flat Pack Inductor or Neckloop (Conventional Version)	\$ 202.44
V1-10611	Wireless Ear Receiver used with Flat Pack Inductor or Neckloop (Squelched Version)	\$ 260.86
V1-10471	Flat Pack Inductor with 2 prong jack for use with existing 2 & 3 Wire Kits	\$ 70.73
V1-10666	28" Universal neck loop	\$ 70.73
V1-10603	49" Universal neck loop	\$ 80.98
C819021	Replacement batteries (4) for Wireless Ear Receiver	\$ 11.26
C101114	Wax Trap (15) and Installation Tool (Replacement Part for Wireless Ear Receiver)	\$ 18.96

<b>HEADSETS</b> <i>Requires Adapter V1-10335</i>		
V4-EX2MA5	Explorer, lightweight, flexible earloop, w/ boom mic, quick-disconnect acoustic tube, mini PTT	\$ 93.15
V4-BA2MA1	Breeze, lightweight, behind-the-head, single spkr with standard PTT	\$ 77.66
* V4-BA2MA3B	Breeze, lightweight, behind-the-head, single spkr w/std. PTT & 2.5mm pigtail for remote PTT	\$ 86.06
V4-10191	Lightweight Single Speaker Padded Headband no PTT	\$ 72.17
V4-10050	Lightweight Single Speaker Padded Headband with standard PTT	\$ 113.85
V4-HC2MA5	Hurricane, lightweight, dual spkr, 21dB reduction, behind-the-head, with mini PTT	\$ 239.98
* V4-HC2MA3B	Hurricane, lightweight, dual spkr, 21dB reduction, behind-the-head, w/std. PTT & 2.5mm pigtail for remote PTT	\$ 249.17
V4-HE2MA5	Hurricane, lightweight, dual spkr, 21dB reduction, behind-the-head, with mini PTT & Extreme Noise Microphone	\$ 259.98
V4-NR2MA1	Ranger Single Speaker behind-the-head with standard PTT	\$ 306.48
*V4-NR2MA3B	Ranger Single Speaker behind-the-head, standard PTT and 2.5mm pigtail for remote PTT	\$ 326.98
V4-10145	Over-the-head Dual Speaker Heavy Duty with standard PTT	\$ 265.40
V4-10002	Behind-the-Head Dual Speaker Heavy Duty with standard PTT	\$ 306.48
V4-10364	ClearTRAK Over-the-Head Dual Speaker Extreme Noise with Earcup PTT	\$ 344.25
V4-10024	ClearTRAK Behind-the-Head Dual Speaker Extreme Noise with Earcup PTT	\$ 385.32
<b>V1-10335</b>	<b>Adapter required with use of above Headsets</b>	\$ 51.25

<b>* REMOTE PTT ACCESSORIES FOR BREEZE, HURRICANE AND RANGER HEADSETS WITH 2.5MM JACK</b>		
V1-10513	Ring PTT with 2.5mm right angle plug, 5' straight cable	\$ 25.63
V1-10519	80mm Round Body PTT with 2.5mm right angle plug, coil cord	\$ 96.77

CONSULT TABLE OF CONTENTS FOR REPLACEMENT PARTS & ADDITIONAL EAR INSERT OPTIONS

# Motorola

XTS3000/Astro, XTS3500, XTS1500/2500/5000, HT1000, MT2000, MTS2000, MTX8000, MTX838, MTX1000, MTX9000, MTX-L5, JT1000, GP900 W/Adapter V1-10335, PR1500  
Visar (No adapter required)

MOTOROLA

PART NUMBER	DESCRIPTION	SUGGESTED RESALE
-------------	-------------	---------------------

SPEAKER MICROPHONES <small>No Adapter Required</small> (These CANNOT Be used with Visar)		
V2-L2MA11	Profile Speaker Microphone with 2.5mm earphone jack	\$ 91.38
V2-10031	Evolution Speaker Mic with Coil cord, volume control and 2.5mm earphone jack	\$ 102.49
V2-10074	Evolution Speaker Mic with Coil cord, Hi for Hi background noise/Lo for low background noise, 2.5mm earphone jack	\$ 102.49
V2-10173	Evolution Speaker Mic with Coil cord, volume control, 2.5mm earphone jack and emergency button	\$ 117.39
V2-10023	Evolution Speaker Mic with Straight Coaxial cord, volume control, 2.5mm earphone jack and antenna connector <small>(HT1000, MT2000, MTS2000, MTX8000, MTX838, MTX9000 and JT1000 only)</small>	\$ 113.73
V2-10139	Evolution Speaker Mic with Coiled Coaxial cord, volume control, 2.5mm earphone jack and antenna connector <small>(HT1000, MT2000, MTS2000, MTX8000, MTX838, MTX9000 and JT1000 only)</small>	\$ 120.85
V2-10202	Evolution Speaker Mic with Coiled Coaxial cord, volume control, 2.5mm earphone jack, antenna connector and emergency button <small>(HT1000, MT2000, MTS2000, MTX8000, MTX838, MTX9000 and JT1000 only)</small>	\$ 139.38
V2-10256	Evolution Speaker Mic with Coaxial Connector, Coiled Coaxial cord, volume control, antenna connector and 2.5mm earphone jack <small>(XTS1500, XTS2500, XTS3000, XTS3500 and XTS5000 only)</small>	\$ 255.50
V2-10268	Speaker Mic Evolution with Coaxial Connector, Straight Coaxial cord, volume control, antenna connector and 2.5mm earphone jack <small>(XTS1500, XTS2500, XTS3000, XTS3500 and XTS5000 only)</small>	\$ 250.17
V2-10286	Evolution Speaker Mic with Coil cord, volume control, 2.5mm earphone jack and emergency button <b>(XTS1500, XTS2500, XTS3000, XTS3500 AND XTS5000 Only)</b>	\$ 134.83
V2-10178	Evolution H20 Immersion Rated (IP68), with Coil Cord, volume control	\$ 122.99
V2-10179	Evolution H20 Immersion Rated (IP68) with Straight Coaxial cord, volume control, and antenna connector <small>(HT1000, MT2000, MTS2000, MTX8000, MTX838, MTX9000 and JT1000 only)</small>	\$ 134.23
V2-10180	Evolution H20 Immersion Rated (IP68) with Coiled Coaxial cord, volume control, and antenna connector <small>(HT1000, MT2000, MTS2000, MTX8000, MTX838, MTX9000 and JT1000 only)</small>	\$ 141.35
<b>V2-D2MA111</b>	<b>Lightsword Speaker with LED, on/off control, coil cord and 2.5mm earphone jack</b>	<b>\$ 180.00</b>
V2-G2MA211	Genesis with Coil Cord	\$ 129.02
V2-G2MA221	Genesis Coil Cord and Emergency Button	\$ 143.55
V2-G2MA213	Genesis Straight Coax Cable and Antenna Connector <small>(HT1000, MT2000, MTS2000, MTX8000, MTX838, MTX9000 and JT1000 only)</small>	\$ 139.98
V2-G2MA223	Genesis Straight Coax Cable, Antenna Connector & Emergency Button <small>(HT1000, MT2000, MTS2000, MTX8000, MTX838, MTX9000 and JT1000 only)</small>	\$ 144.98
V2-G2MA212	Genesis Coiled Coax Cable and Antenna Connector <small>(HT1000, MT2000, MTS2000, MTX8000, MTX838, MTX9000 and JT1000 only)</small>	\$ 146.92
V2-G2MA222	Genesis Coiled Coax Cable, Antenna Connector & Emergency Button <small>(HT1000, MT2000, MTS2000, MTX8000, MTX838, MTX9000 and JT1000 only)</small>	\$ 170.00
V2-G2MA311	Genesis with Coil Cord & Accessory Jack	\$ 144.02
V2-G2MA321	Genesis Coil Cord, Emergency Button & Accessory Jack	\$ 158.57
V2-G2MA313	Genesis Straight Coax Cable, Antenna Connector & Accessory Jack <small>(HT1000, MT2000, MTS2000, MTX8000, MTX838, MTX9000 and JT1000 only)</small>	\$ 154.98
V2-G2MA323	Genesis Straight Coax Cable, Antenna Connector, Emergency Button & Accessory Jack <small>(HT1000, MT2000, MTS2000, MTX8000, MTX838, MTX9000 and JT1000 only)</small>	\$ 159.98
V2-G2MA312	Genesis Coiled Coax Cable, Antenna Connector & Accessory Jack <small>(HT1000, MT2000, MTS2000, MTX8000, MTX838, MTX9000 and JT1000 only)</small>	\$ 161.92
V2-G2MA322	Genesis Coiled Coax Cable, Antenna Connector, Emergency Button & Accessory Jack <small>(HT1000, MT2000, MTS2000, MTX8000, MTX838, MTX9000 and JT1000 only)</small>	\$ 185.00
V2-G2MX322	Genesis Coaxial Connector, Coiled Coax Cable, Emergency Button, Antenna Connector and Accessory Jack <small>(XTS1500, XTS2500, XTS3000, XTS3500, XTS5000 only)</small>	\$ 285.00

EARPHONE KITS FOR USE WITH EVOLUTION, LIGHTSWORD AND PROFILE SPEAKER MICROPHONES ONLY		
V1-10282	2.5mm straight plug, coil cord (30" extended length), black	\$ 47.44
V1-10432	2.5mm right angle plug, coil cord (30" extended length), black	\$ 47.44
V1-EH22R131	2.5mm right angle plug, <b>Earhanger</b> , coil cord (30" extended length), black	\$ 26.93
V1-10433	3.5mm right angle plug, coil cord (30" extended length) black	\$ 47.44
V1-10305	3.5mm straight plug, coil cord (30" extended length), black	\$ 47.44

continued on page 46

# Motorola

XTS3000/Astro, XTS3500, XTS1500/2500/5000, HT1000, MT2000, MTS2000, MTX8000, MTX838, MTX1000, MTX9000, MTX-LS, JT1000, GP900 W/Adapter V1-10335, PR1500  
 Visar (No adapter required)

PART NUMBER	DESCRIPTION	SUGGESTED RESALE
-------------	-------------	---------------------

**ACCESSORIES FOR GENESIS WITH ACCESSORY JACK OPTION**

V1-10750	Earphone with acoustic tube and Hirose Connector	\$ 91.78
V4-10478	Hurricane, lightweight, dual sprk, 21db reduction, behind-the-head with Hirose Connector	\$ 265.38
V1-10656	Throat Microphone with Hirose Connector	\$ 289.58
V4-10421	Ranger Single Speaker, behind-the-head, no PTT with Hirose Connector	\$ 291.84
V4-10450	Behind-the-head Dual Speaker Heavy Duty with no PTT	\$ 306.24
V4-10428	Skull Microphone with Hirose Connector	\$ 318.81
V3-10301	SCBA-ISI Hirose Connector Interface Cable	\$ 115.38

**TACTICAL, FIRE, & HAZMAT COMMUNICATIONS EQUIPMENT *No Adapter Required***  
*(These CANNOT be used with Visar radio)*

V1-T12MA137	Throat Microphone with Acoustic Tube & 80 MM PTT	\$ 470.48
V1-T12MA117	Throat Microphone with Acoustic Tube, 80 MM PTT and Remote Ring PTT	\$ 526.85
V4-10231	Skull Microphone with Earcup & 80 MM PTT	\$ 562.73
V3-10339	SCBA-ISI Hirose Connector Interface Cable	\$ 175.00

**CONSULT TABLE OF CONTENTS FOR REPLACEMENT PARTS & ADDITIONAL EAR INSERT OPTIONS**  
**CONTACT FACTORY FOR ALL INTRINSICALLY SAFE APPROVED PRODUCTS**

# Motorola

HT600, MT1000, MTX800, MTX Classic, MTX900, P200 with Motorola adapter NTN5598  
SABER/ASTRO with Motorola adapter NTN5213 or NTN5664 Keyload adapter

6 Pin Hirose Connector



PART NUMBER	DESCRIPTION	SUGGESTED RESALE
<b>SURVEILLANCE KITS</b>		
V1-10168	1 Wire Earphone Kit <b>Black (Receive only no transmit)</b>	\$ 63.59
V1-10167	1 Wire Earphone Kit <b>Beige (Receive only no transmit)</b>	\$ 63.59
V1-10777	2 Wire Earbud <b>Black</b>	\$ 80.00
V1-10166	2 Wire Palm Microphone Kit <b>Black</b>	\$ 152.49
V1-10165	2 Wire Palm Microphone Kit <b>Beige</b>	\$ 152.49
V1-10164	3 Wire Mini Lapel Microphone Kit <b>Black</b>	\$ 197.89
V1-10163	3 Wire Mini Lapel Microphone Kit <b>Beige</b>	\$ 197.89
<b>EAR INSERT OPTIONS</b> <small>Consult table of contents for additional Ear Insert Options</small>		
C800947	Regular Clear Ear Tip	\$ 1.06
C100733	Noise Attenuating Plugs (NRR 25dB)	\$ 2.33
C806573-LM	Flexible Open Ear Inserts Left, Medium	\$ 15.38
C806573-RM	Flexible Open Ear Inserts Right, Medium	\$ 15.38
<b>WIRELESS ACCESSORIES FOR USE WITH SURVEILLANCE KITS</b>		
V1-10610	Wireless Ear Receiver used with Flat Pack Inductor or Neckloop (Conventional Version)	\$ 202.44
V1-10611	Wireless Ear Receiver used with Flat Pack Inductor or Neckloop (Squelched Version)	\$ 260.86
V1-10471	Flat Pack Inductor with 2 prong jack for use with existing 2 & 3 Wire Kits	\$ 70.73
V1-10666	28" Universal neck loop	\$ 70.73
V1-10603	49" Universal neck loop	\$ 80.98
C819021	Replacement batteries (4) for Wireless Ear Receiver	\$ 11.26
C101114	Wax Trap (15) and Installation Tool (Replacement Part for Wireless Ear Receiver)	\$ 18.96
<b>HEADSETS</b>		
V4-BA2MD1	Breeze, lightweight, behind-the-head, single spkr with standard PTT	\$ 102.40
* V4-BA2MD3B	Breeze, lightweight, behind-the-head, single spkr w/std. PTT & 2.5mm pigtail for remote PTT	\$ 109.92
V4-10190	Lightweight Single Speaker Padded Headband with standard PTT	\$ 126.87
V4-HC2MD3B	Hurricane, lightweight, dual spkr, 21dB reduction, behind-the-head, w/std. PTT & 2.5mm pigtail for remote PTT	\$ 291.00
V4-NR2MD1	Ranger Single Speaker behind-the-head with standard PTT	\$ 306.48
V4-10148	Over-the-head Dual Speaker Heavy Duty with standard PTT	\$ 280.54
V4-10001	Behind-the-Head Dual Speaker Heavy Duty with standard PTT	\$ 370.18
<b>* REMOTE PTT ACCESSORIES FOR BREEZE HEADSETS WITH 2.5MM JACK</b>		
V1-10513	Ring PTT with 2.5mm right angle plug, 5' straight cable	\$ 25.63
V1-10519	80mm Round Body PTT with 2.5mm right angle plug, coil cord	\$ 96.77
<b>SPEAKER MICROPHONES SABER / ASTRO Radios Only</b>		
V2-10024	Evolution Speaker Mic with Coil cord, volume control and 2.5mm earphone jack	\$ 157.83
V2-10270	Evolution Speaker Mic with Coiled Coaxial Cord, Volume Control and 2.5mm earphone jack, and antenna connector	\$ 177.00
V2-10283	Evolution Speaker Mic with Coiled Coaxial Cord, volume control and 2.5mm earphone jack, and antenna connector (Used with Saber/Astro that have the special RF Pin)	\$ 177.00
V2-G2MC211	Genesis with Coil Cord	\$ 183.00
V2-G2MC311	Genesis with Coil Cord & Accessory Jack	\$ 198.00
<b>EARPHONE KITS FOR USE WITH MOTOROLA SABER / ASTRO REMOTE SPEAKER MICROPHONE ONLY</b>		
V1-10749	2.5mm straight plug, coil cord (30" extended length), black	\$ 47.44
V1-10747	2.5mm right angle plug, coil cord (30" extended length), black	\$ 47.44
<b>EARPHONE KITS FOR USE WITH EVOLUTION REMOTE SPEAKER MICROPHONES ONLY</b>		
V1-10282	2.5mm straight plug, coil cord (30" extended length), black	\$ 47.44
V1-10432	2.5mm right angle plug, coil cord (30" extended length), black	\$ 47.44
V1-EH22R131	2.5mm right angle plug, <b>Earhanger</b> , coil cord (30" extended length), black	\$ 26.93
V1-10305	3.5mm straight plug, coil cord (30" extended length), black	\$ 47.44
V1-10433	3.5mm right angle plug, coil cord (30" extended length) black	\$ 47.44
<b>ACCESSORIES FOR GENESIS WITH ACCESSORY JACK OPTION</b>		
V1-10750	Earphone with acoustic tube and Hirose Connector	\$ 91.78
V4-10478	Hurricane, lightweight, dual spkr, 21db reduction, behind-the-head with Hirose Connector	\$ 265.38
V1-10656	Throat Microphone with Hirose Connector	\$ 289.58
V4-10421	Ranger Single Speaker, behind-the-head, no PTT with Hirose Connector	\$ 291.84
V4-10450	Behind-the-head Dual Speaker Heavy Duty with no PTT	\$ 306.24
V4-10428	Skull Microphone with Hirose Connector	\$ 318.81
V3-10301	SCBA-ISI Hirose Connector Interface Cable	\$ 115.38
<b>TACTICAL, FIRE, &amp; HAZMAT COMMUNICATIONS EQUIPMENT</b>		
V4-10279	Skull Microphone with Earcup & 80 MM PTT	\$ 588.35
V1-T12MD137	Throat Microphone with acoustic tube & 80mm PTT	\$ 513.75

CONSULT TABLE OF CONTENTS FOR REPLACEMENT PARTS & ADDITIONAL EAR INSERT OPTIONS

CONTACT FACTORY FOR ALL INTRINSICALLY SAFE APPROVED PRODUCTS

## PUBLIC SAFETY SPECIAL ACCESSORIES

The following kits allow the interchangeability of one set of accessories with either the XTS3000 / XTS5000 radios or the Saber/Astro radios. The components shown in the V-6 10001 system allow keyloading through the mic or the body PTT. This enables the user to utilize the 12 pin connector that is most conveniently located for this purpose. Unlike 6 pin keyload adapters currently in the market, the OTTO 12 pin adapter will support **both** portable and mobile keyloading **AND** a full range of accessory options without the need to remove the adapter.

**With the exception of the keyload cables, these accessories may be used on EF Johnson 5100 series and Motorola models that use the XTS3000 style connector.**

PART NO.	COMMENTS	DESCRIPTION	SUGGESTED RESALE
----------	----------	-------------	------------------

### Used on XTS3000 / XTS5000 Series Radios

V1-10537		Adapter - XTS3000 / HT1000 Series w/12 pin Hirose jack	\$ 105.00
V3-10184		Cable-Keyload with 12 pin Hirose connector to MX	\$ 159.00
V2-10256		Speaker Mic - Evolution with Coaxial Connector, Coiled Coaxial cord, volume control, antenna connector and 2.5mm earphone jack (XTS1500, XTS2500, XTS3000, XTS3500 and XTS5000 only)	\$ 255.50
V2-10268		Speaker Mic - Evolution with Coaxial Connector, Straight Coaxial cord, volume control, antenna connector and 2.5mm earphone jack (XTS1500, XTS2500, XTS3000, XTS3500 and XTS5000 only)	\$ 250.17
V2-G2MX322		Speaker Mic - Genesis Coaxial Connector, Coiled Coax Cable, Emergency Button, Antenna Connector and Accessory Jack (XTS1500, XTS2500, XTS3000, XTS3500, XTS5000 only)	\$ 285.00

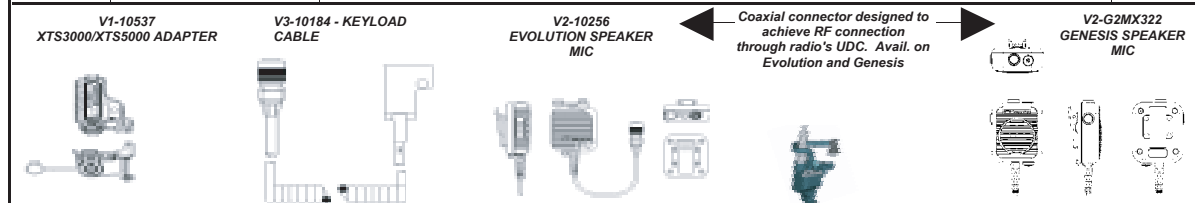

### Used on Saber/Astro Radios

V1-10581		Adapter - Saber side connector with 12 pin Hirose jack	\$ 105.00
V3-10160		Cable - Keyload, Astro/Spectra (Remote) *	\$ 155.00
C201442		Repl - Clamp for Spectra end of cable	\$ 2.50

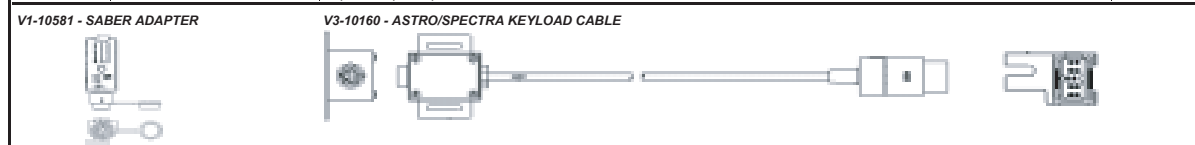

### Used on XTS3000 Series & Saber/Astro radios with OTTO 12 pin adapters

V1-10550		3 wire mini lapel mic kit w/12 pin Hirose connector, barrel PTT (Standard), beige	\$ 172.78
V1-10706		3 wire mini lapel mic kit w/12 pin Hirose connector, barrel PTT (Standard), black	\$ 172.78
V1-10705		2 wire palm mic kit w/12 pin Hirose connector, beige	\$ 150.00
V1-10697		2 wire palm mic kit w/12 pin Hirose connector, black	\$ 150.00
V1-10547		Neckloop w/mic, 12 pin Hirose Connector, barrel PTT, beige	\$ 300.00
V1-10714		Neckloop w/mic, 12 pin Hirose Connector, barrel PTT, black	\$ 300.00
V1-10483	Used with neckloops or flat packs	Ear receiver, wireless, squelched, beige	\$ 260.86
V1-10715	Used with neckloops or flat packs	Ear receiver, wireless, squelched, dark brown	\$ 260.86
V1-10696		Ear Microphone with 80mm PTT	\$ 435.63
V1-10696R		Ear Microphone with 80mm PTT (Right Ear)	\$ 435.63
V2-10143		Speaker mic - Evolution, str. cord, 12pin Hirose jack on top, 12 pin Hirose connector.	\$ 180.86
V2-10264		Speaker mic - Evolution, coiled cord, 12pin Hirose jack on top, 12 pin Hirose connector.	\$ 180.86
V4-10461		Headset - Explorer w/high mic gain, std. PTT w/pigtail, 12 pin Hirose connector	\$ 132.26
V4-BA22P3B		Headset - Breeze lightweight, behind-the-head, std. PTT w/pigtail, 12 pin Hirose connector	\$ 113.87
V4-10457		Headset - Lightweight, single speaker, padded band w/std. PTT, 12 pin Hirose connector	\$ 137.20
V4-HE22P3B		Headset - Hurricane w/extreme noise mic, std. PTT w/pigtail, 12 pin Hirose connector	\$ 252.98
V4-10455		Headset - ClearTRAK behind-the-head dual speaker extreme noise w/earcup PTT	\$ 415.87
<b>V6-10001 - Ambient sound system</b>			<b>\$ 781.97</b>
V4-10222	Used alone or w/V6-10001 system	Headset - Ambient noise headset with 12 pin Hirose connector	\$ 485.00
V1-10554	Used with V6-10001 system	PTT - 80mm body PTT w/12 pin Hirose connector & 12 pin jack for headset	\$ 204.00
V2-10143	Used alone or with systems	Speaker mic - Evolution, str. cord, 12pin Hirose jack on top, 12 pin Hirose connector.	\$ 180.86

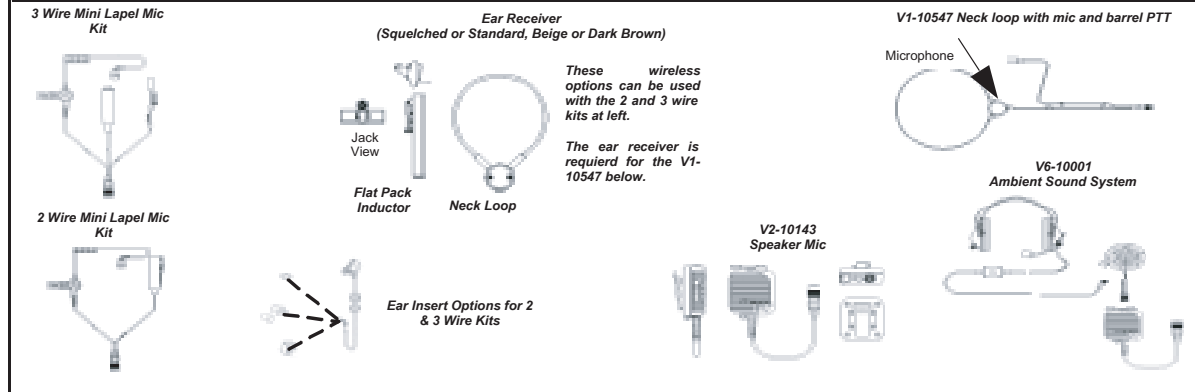



# Relm Wireless Radios

DPH, EPU, EPH, EPV, EPI LPH, LPU, LPX, GPH

Assembled Connector



PART NUMBER	DESCRIPTION	SUGGESTED RESALE
-------------	-------------	---------------------

### SURVEILLANCE KITS

V1-10434	1 Wire Earphone Kit <b>Black (Receive only no transmit)</b>	\$ 46.56
V1-10435	1 Wire Earphone Kit <b>Beige (Receive only no transmit)</b>	\$ 46.56
V1-10249	2 Wire Palm Microphone Kit <b>Black</b>	\$ 127.50
V1-10248	2 Wire Palm Microphone Kit <b>Beige</b>	\$ 127.50
V1-10251	3 Wire Mini Lapel Microphone Kit <b>Black</b>	\$ 158.32
V1-10250	3 Wire Mini Lapel Microphone Kit <b>Beige</b>	\$ 158.32

### EAR INSERT OPTIONS Consult table of contents for additional Ear Insert Options

C800947	Regular Clear Ear Tip	\$ 1.06
C100733	Noise Attenuating Plugs <b>(NRR 25dB)</b>	\$ 2.33
C806573-LM	Flexible Open Ear Inserts Left, Medium	\$ 15.38
C806573-RM	Flexible Open Ear Inserts Right, Medium	\$ 15.38

### WIRELESS ACCESSORIES FOR USE WITH SURVEILLANCE KITS

V1-10610	Wireless Ear Receiver used with Flat Pack Inductor or Neckloop (Conventional Version)	\$ 202.44
V1-10611	Wireless Ear Receiver used with Flat Pack Inductor or Neckloop (Squelched Version)	\$ 260.86
V1-10471	Flat Pack Inductor with 2 prong jack for use with existing 2 & 3 Wire Kits	\$ 70.73
V1-10666	28" Universal neck loop	\$ 70.73
V1-10603	49" Universal neck loop	\$ 80.98
C819021	Replacement batteries (4) for Wireless Ear Receiver	\$ 11.26
C101114	Wax Trap (15) and Installation Tool (Replacement Part for Wireless Ear Receiver)	\$ 18.96

### HEADSETS

V4-BA2BA1	Breeze, lightweight, behind-the-head, single spkr with standard PTT	\$ 90.39
V4-10032	Lightweight Single Speaker Padded Headband with standard PTT	\$ 138.52
V4-HC2BA1	Hurricane, lightweight, dual spkr, 21dB reduction, behind-the-head, with PTT	\$ 250.00
V4-NR2BA1	Ranger Single Speaker behind-the-head with standard PTT	\$ 316.73
V4-10014	Over-the-head Dual Speaker Heavy Duty with PTT	\$ 344.56
V4-10015	Behind-the-Head Dual Speaker Heavy Duty with PTT	\$ 395.78

### SPEAKER MICROPHONES

V2-10029	Evolution Speaker Mic with Coil cord, volume control and 2.5mm earphone jack	\$ 108.39
V2-G2BA211	Genesis with Coil Cord	\$ 129.02
V2-G2BA311	Genesis with Coil Cord and Accessory Jack	\$ 144.02

### EARPHONE KITS FOR USE WITH EVOLUTION AND PROFILE REMOTE SPEAKER MICROPHONES ONLY

V1-10282	2.5mm straight plug, coil cord (30" extended length), black	\$ 47.44
V1-10432	2.5mm right angle plug, coil cord (30" extended length), black	\$ 47.44
V1-EH22R131	2.5mm right angle plug, <b>Earhanger</b> , coil cord (30" extended length), black	\$ 26.93
V1-10305	3.5mm straight plug, coil cord (30" extended length), black	\$ 47.44
V1-10433	3.5mm right angle plug, coil cord (30" extended length) black	\$ 47.44

### ACCESSORIES FOR GENESIS WITH ACCESSORY JACK OPTION

V1-10750	Earphone with acoustic tube and Hirose Connector	\$ 91.78
V4-10478	Hurricane, lightweight, dual spkr, 21db reduction, behind-the-head with Hirose Connector	\$ 265.38
V1-10656	Throat Microphone with Hirose Connector	\$ 289.58
V4-10421	Ranger Single Speaker, behind-the-head, no PTT with Hirose Connector	\$ 291.84
V4-10450	Behind-the-head Dual Speaker Heavy Duty with no PTT	\$ 306.24
V4-10428	Skull Microphone with Hirose Connector	\$ 318.81
V3-10301	SCBA-ISI Hirose Connector Interface Cable	\$ 115.38

### TACTICAL, FIRE, & HAZMAT COMMUNICATIONS EQUIPMENT

V4-10485	Skull Microphone with Earcup & 80 MM PTT	\$ 560.73
----------	--	-----------

**CONSULT TABLE OF CONTENTS FOR REPLACEMENT PARTS & ADDITIONAL EAR INSERT OPTIONS**

**CONTACT FACTORY FOR ALL INTRINSICALLY SAFE APPROVED PRODUCTS**

RELm WIRELESS

# Tait

2.5mm/3.5mm Right Angle Connector

Orca (With Adapter TOPA-AA-005)



PART NUMBER	DESCRIPTION	SUGGESTED RESALE
-------------	-------------	------------------

## SURVEILLANCE KITS

V1-10178	1 Wire Earphone Kit <b>Black (Receive only no transmit)</b>	\$ 36.92
V1-10177	1 Wire Earphone Kit <b>Beige (Receive only no transmit)</b>	\$ 36.92
V1-B22MG131	2 Wire Earbud <b>Black</b>	\$ 48.43
V1-10176	2 Wire Palm Microphone Kit <b>Black</b>	\$ 105.66
V1-10175	2 Wire Palm Microphone Kit <b>Beige</b>	\$ 105.66
V1-10338	2 Wire Field <b>Repairable</b> Palm Microphone Kit	\$ 113.66
V1-10284	3 Wire Mini Lapel Microphone Kit <b>Black</b>	\$ 118.37
V1-10283	3 Wire Mini Lapel Microphone Kit <b>Beige</b>	\$ 118.37

## EAR INSERT OPTIONS *Consult table of contents for additional Ear Insert Options*

C800947	Regular Clear Ear Tip	\$ 1.06
C100733	Noise Attenuating Plugs ( <b>NRR 25dB</b> )	\$ 2.33
C806573-LM	Flexible Open Ear Inserts Left, Medium	\$ 15.38
C806573-RM	Flexible Open Ear Inserts Right, Medium	\$ 15.38

## WIRELESS ACCESSORIES FOR USE WITH SURVEILLANCE KITS

V1-10610	Wireless Ear Receiver used with Flat Pack Inductor or Neckloop (Conventional Version)	\$ 202.44
V1-10611	Wireless Ear Receiver used with Flat Pack Inductor or Neckloop (Squelched Version)	\$ 260.86
V1-10471	Flat Pack Inductor with 2 prong jack for use with existing 2 & 3 Wire Kits	\$ 70.73
V1-10666	28" Universal neck loop	\$ 70.73
V1-10603	49" Universal neck loop	\$ 80.98
C819021	Replacement batteries (4) for Wireless Ear Receiver	\$ 11.26
C101114	Wax Trap (15) and Installation Tool (Replacement Part for Wireless Ear Receiver)	\$ 18.96

## HEADSETS

V4-EX2MG2	Explorer, lightweight, flexible earloop w/boom mic, quick-disconnect acoustic tube, no PTT	\$ 58.43
V4-EX2MG5	Explorer, lightweight, flexible earloop, w/ boom mic, quick-disconnect acoustic tube, mini PTT	\$ 74.19
V4-BA2MG2	Breeze, lightweight, behind-the-head, single spkr, no PTT	\$ 47.68
V4-BA2MG5	Breeze, lightweight, behind-the-head, single spkr, with mini PTT	\$ 56.76
V4-BA2MG1	Breeze, lightweight, behind-the-head, single spkr with standard PTT	\$ 77.66
* V4-BA2MG3B	Breeze, lightweight, behind-the-head, single spkr w/std. PTT & 2.5mm pigtail for remote PTT	\$ 86.06
V4-BH2MG2	Breeze, lightweight, behind-the-head, <b>adjustable headband</b> , single spkr, no PTT	\$ 52.63
V4-BH2MG5	Breeze, lightweight, behind-the-head, <b>adjustable headband</b> , single spkr, mini PTT	\$ 61.71
V4-10192	Lightweight Single Speaker Padded Headband no PTT	\$ 72.17
V4-10053	Lightweight Single Speaker Padded Headband with standard PTT	\$ 113.86
V4-HC2MG2	Hurricane, lightweight, dual spkr, 21dB reduction, behind-the-head, no PTT	\$ 199.67
V4-HC2MG5	Hurricane, lightweight, dual spkr, 21dB reduction, behind-the-head, with mini PTT	\$ 234.67
* V4-HC2MG3B	Hurricane, lightweight, dual spkr, 21dB reduction, behind-the-head, w/std. PTT & 2.5mm pigtail for remote PTT	\$ 250.00
V4-HE2MG5	Hurricane, lightweight, dual spkr, 21dB reduction, behind-the-head, with mini PTT & Extreme Noise Microphone	\$ 254.67
V4-NR2MG1	Ranger Single Speaker behind-the-head with standard PTT	\$ 306.48
V4-10146	Over-the-head Dual Speaker Heavy Duty with standard PTT	\$ 239.70
V4-10003	Behind-the-Head Dual Speaker Heavy Duty with standard PTT	\$ 299.82
V4-10390	ClearTRAK Over-the-Head Dual Speaker Extreme Noise with Earcup PTT	\$ 318.52
V4-10047	ClearTRAK Behind-the-Head Dual Speaker Extreme Noise with Earcup PTT	\$ 378.34

## REMOTE PTT ACCESSORIES FOR BREEZE HEADSETS WITH 2.5MM JACK

V1-10513	Ring PTT with 2.5mm right angle plug, 5' straight cable	\$ 25.63
V1-10519	80mm Round Body PTT with 2.5mm right angle plug, coil cord	\$ 96.77

**Tait**  
Orca (With Adapter TOPA-AA-005)

PART NUMBER	DESCRIPTION	SUGGESTED RESALE
-------------	-------------	---------------------

SPEAKER MICROPHONES		
V2-C2MG11	Legacy Speaker Microphone with 2.5mm earphone jack	\$ 37.44
V2-L2MG11	Profile Speaker Microphone with 2.5mm earphone jack	\$ 66.24
V2-10026	Evolution Speaker Mic with Coil cord, volume control and 2.5mm earphone jack	\$ 78.69
V2-10220	Evolution H20 Immersion Rated (IP68), with Coil Cord, volume control	\$ 108.81
V2-G2MG211	Genesis with Coil Cord	\$ 115.17

EARPHONE KITS FOR USE WITH EVOLUTION AND PROFILE REMOTE SPEAKER MICROPHONES ONLY		
V1-10282	2.5mm straight plug, coil cord (30" extended length), black	\$ 47.44
V1-10432	2.5mm right angle plug, coil cord (30" extended length), black	\$ 47.44
V1-EH22R131	2.5mm right angle plug, <b>Earhanger</b> , coil cord (30" extended length), black	\$ 26.93
V1-10305	3.5mm straight plug, coil cord (30" extended length), black	\$ 47.44
V1-10433	3.5mm right angle plug, coil cord (30" extended length) black	\$ 47.44

EARPHONE KIT FOR USE WITH LEGACY SPEAKER MICROPHONE ONLY		
V1-10598	2.5mm straight plug Coil Cord (12" length), black	\$ 29.95

TACTICAL, FIRE, & HAZMAT COMMUNICATIONS EQUIPMENT		
V1-T12MG137	Throat Microphone with Acoustic Tube & 80 MM PTT	\$ 439.73

**CONSULT TABLE OF CONTENTS FOR REPLACEMENT PARTS & ADDITIONAL EAR INSERT OPTIONS**  
**CONTACT FACTORY FOR ALL INTRINSICALLY SAFE APPROVED PRODUCTS**

**TAIT**

**Thales 25**  
**Requires Thales Adapter 85305**

6 Pin Hirose Connector



PART NUMBER	DESCRIPTION	SUGGESTED RESALE
-------------	-------------	---------------------

**SURVEILLANCE KITS**

V1-10168	1 Wire Earphone Kit <b>Black (Receive only no transmit)</b>	\$ 63.59
V1-10167	1 Wire Earphone Kit <b>Beige (Receive only no transmit)</b>	\$ 63.59
V1-10777	2 Wire Earbud <b>Black</b>	\$ 80.00
V1-10166	2 Wire Palm Microphone Kit <b>Black</b>	\$ 152.49
V1-10165	2 Wire Palm Microphone Kit <b>Beige</b>	\$ 152.49
V1-10164	3 Wire Mini Lapel Microphone Kit <b>Black</b>	\$ 197.89
V1-10163	3 Wire Mini Lapel Microphone Kit <b>Beige</b>	\$ 197.89

**EAR INSERT OPTIONS** *Consult table of contents for additional Ear Insert Options*

C800947	Regular Clear Ear Tip	\$ 1.06
C100733	Noise Attenuating Plugs ( <b>NRR 25dB</b> )	\$ 2.33
C806573-LM	Flexible Open Ear Inserts Left, Medium	\$ 15.38
C806573-RM	Flexible Open Ear Inserts Right, Medium	\$ 15.38

**WIRELESS ACCESSORIES FOR USE WITH SURVEILLANCE KITS**

V1-10610	Wireless Ear Receiver used with Flat Pack Inductor or Neckloop (Conventional Version)	\$ 202.44
V1-10611	Wireless Ear Receiver used with Flat Pack Inductor or Neckloop (Squelched Version)	\$ 260.86
V1-10471	Flat Pack Inductor with 2 prong jack for use with existing 2 & 3 Wire Kits	\$ 70.73
V1-10666	28" Universal neck loop	\$ 70.73
V1-10603	49" Universal neck loop	\$ 80.98
C819021	Replacement batteries (4) for Wireless Ear Receiver	\$ 11.26
C101114	Wax Trap (15) and Installation Tool (Replacement Part for Wireless Ear Receiver)	\$ 18.96

**HEADSETS**

V4-BA2MD1	Breeze, lightweight, behind-the-head, single spkr with standard PTT	\$ 102.40
* V4-BA2MD3B	Breeze, lightweight, behind-the-head, single spkr w/std. PTT & 2.5mm pigtail for remote PTT	\$ 109.92
V4-10190	Lightweight Single Speaker Padded Headband with standard PTT	\$ 126.87
V4-HC2MD3B	Hurricane, lightweight, dual spkr, 21dB reduction, behind-the-head, w/std. PTT & 2.5mm pigtail for remote PTT	\$ 291.00
V4-NR2MD1	Ranger Single Speaker behind-the-head with standard PTT	\$ 306.48
V4-10148	Over-the-head Dual Speaker Heavy Duty with standard PTT	\$ 280.54
V4-10001	Behind-the-Head Dual Speaker Heavy Duty with standard PTT	\$ 370.18

**\* REMOTE PTT ACCESSORIES FOR BREEZE AND HURRICANE HEADSETS WITH 2.5MM JACK**

V1-10513	Ring PTT with 2.5mm right angle plug, 5' straight cable	\$ 25.63
V1-10519	80mm Round Body PTT with 2.5mm right angle plug, coil cord	\$ 96.77

**EARPHONE KITS FOR USE WITH THALES REMOTE SPEAKER MICROPHONE ONLY**

V1-10282	2.5mm straight plug, coil cord (30" extended length), black	\$ 47.44
V1-10432	2.5mm right angle plug, coil cord (30" extended length), black	\$ 47.44
V1-EH22R131	2.5mm right angle plug, <b>Earhanger</b> coil cord (30" extended length), black	\$ 26.93
V1-10305	3.5mm straight plug, coil cord (30" extended length), black	\$ 47.44
V1-10433	3.5mm right angle plug, coil cord (30" extended length) black	\$ 47.44

**CONSULT TABLE OF CONTENTS FOR REPLACEMENT PARTS & ADDITIONAL EAR INSERT OPTIONS**  
**CONTACT FACTORY FOR ALL INTRINSICALLY SAFE APPROVED PRODUCTS**

# Vertex/Yaesu

VX-10, VX300, VXF-1

Single Pin Right Angle Stereo Connector



PART NUMBER	DESCRIPTION	SUGGESTED RESALE
-------------	-------------	------------------

## SURVEILLANCE KITS

V1-10393	2 Wire Palm Microphone Kit <b>Black</b>	\$ 87.89
V1-10394	3 Wire Mini Lapel Microphone Kit <b>Black</b>	\$ 162.96

## EAR INSERT OPTIONS *Consult table of contents for additional Ear Insert Options*

C800947	Regular Clear Ear Tip	\$ 1.06
C100733	Noise Attenuating Plugs (NRR 25dB)	\$ 2.33
C806573-LM	Flexible Open Ear Inserts Left, Medium	\$ 15.38
C806573-RM	Flexible Open Ear Inserts Right, Medium	\$ 15.38

## WIRELESS ACCESSORIES FOR USE WITH SURVEILLANCE KITS

V1-10610	Wireless Ear Receiver used with Flat Pack Inductor or Neckloop (Conventional Version)	\$ 202.44
V1-10611	Wireless Ear Receiver used with Flat Pack Inductor or Neckloop (Squelched Version)	\$ 260.86
V1-10471	Flat Pack Inductor with 2 prong jack for use with existing 2 & 3 Wire Kits	\$ 70.73
V1-10666	28" Universal neck loop	\$ 70.73
V1-10603	49" Universal neck loop	\$ 80.98
C819021	Replacement batteries (4) for Wireless Ear Receiver	\$ 11.26
C101114	Wax Trap (15) and Installation Tool (Replacement Part for Wireless Ear Receiver)	\$ 18.96

## HEADSETS

V4-EX2VA5	Explorer, lightweight, flexible earloop w/boom mic, quick-disconnect acoustice tube, mini-PTT	\$ 73.13
V4-BA2VA1	Breeze, lightweight, behind-the-head, single spkr with standard PTT	\$ 77.66
V4-10114	Lightweight Single Speaker Padded Headband with standard PTT	\$ 102.15
V4-10118	Over-the-head Dual Speaker Heavy Duty with standard PTT	\$ 282.87
V4-10117	Behind-the-Head Dual Speaker Heavy Duty with standard PTT	\$ 331.76
V4-10377	ClearTRAK Behind-the-Head Dual Speaker Extreme Noise with Earcup PTT	\$ 395.37

## SPEAKER MICROPHONES

V2-C2VA11	Legacy Speaker Microphone with 2.5mm earphone jack	\$ 37.44
V2-L2VA11	Profile Speaker Microphone with 2.5mm earphone jack	\$ 63.91
V2-10106	Evolution Speaker Mic with Coil cord, volume control and 2.5mm earphone jack	\$ 89.18

## EARPHONE KITS FOR USE WITH EVOLUTION AND PROFILE REMOTE SPEAKER MICROPHONES ONLY

V1-10282	2.5mm straight plug, coil cord (30" extended length), black	\$ 47.44
V1-10432	2.5mm right angle plug, coil cord (30" extended length), black	\$ 47.44
V1-EH22R131	2.5mm right angle plug, <b>Earhanger</b> , coil cord (30" extended length), black	\$ 26.93
V1-10305	3.5mm straight plug, coil cord (30" extended length), black	\$ 47.44
V1-10433	3.5mm right angle plug, coil cord (30" extended length) black	\$ 47.44

## EARPHONE KIT FOR USE WITH LEGACY SPEAKER MICROPHONE ONLY

V1-10598	2.5mm straight plug Coil Cord (12" length), black	\$ 29.95
----------	---	----------

**CONSULT TABLE OF CONTENTS FOR REPLACEMENT PARTS & ADDITIONAL EAR INSERT OPTIONS**

**CONTACT FACTORY FOR ALL INTRINSICALLY SAFE APPROVED PRODUCTS**

## Vertex/Yaesu VX-310

2.5mm/3.5mm Right Angle Connector



PART NUMBER	DESCRIPTION	SUGGESTED RESALE
-------------	-------------	---------------------

### SURVEILLANCE KITS

V1-10671	2 Wire Palm Microphone Kit <b>Black</b>	\$ 87.89
V1-10672	3 Wire Mini Lapel Microphone Kit <b>Black</b>	\$ 162.96

### EAR INSERT OPTIONS: *Consult table of contents for additional Ear Insert Options*

C800947	Regular Clear Ear Tip	\$ 1.06
C100733	Noise Attenuating Plugs ( <b>NRR 25dB</b> )	\$ 2.33
C806573-LM	Flexible Open Ear Inserts Left, Medium	\$ 15.38
C806573-RM	Flexible Open Ear Inserts Right, Medium	\$ 15.38

### WIRELESS ACCESSORIES FOR USE WITH SURVEILLANCE KITS

V1-10610	Wireless Ear Receiver used with Flat Pack Inductor or Neckloop (Conventional Version)	\$ 202.44
V1-10611	Wireless Ear Receiver used with Flat Pack Inductor or Neckloop (Squelched Version)	\$ 260.86
V1-10471	Flat Pack Inductor with 2 prong jack for use with existing 2 & 3 Wire Kits	\$ 70.73
V1-10666	28" Universal neck loop	\$ 70.73
V1-10603	49" Universal neck loop	\$ 80.98
C819021	Replacement batteries (4) for Wireless Ear Receiver	\$ 11.26
C101114	Wax Trap (15) and Installation Tool (Replacement Part for Wireless Ear Receiver)	\$ 18.96

### HEADSETS

V4-BA2VG1	Breeze, lightweight, behind-the-head, single spkr with standard PTT	\$ 55.20
V4-HC2VG5	Hurricane, lightweight, dual spkr, 21dB reduction, behind-the-head, with mini PTT	\$ 224.98

### SPEAKER MICROPHONES

V2-10242	Evolution Speaker Mic with Coil cord, volume control and 2.5mm earphone jack	\$ 83.70
----------	--	----------

### EARPHONE KITS FOR USE WITH EVOLUTION AND PROFILE REMOTE SPEAKER MICROPHONES ONLY

V1-10282	2.5mm straight plug, coil cord (30" extended length), black	\$ 47.44
V1-10432	2.5mm right angle plug, coil cord (30" extended length), black	\$ 47.44
V1-EH22R131	2.5mm right angle plug, <b>Earhanger</b> , coil cord (30" extended length), black	\$ 26.93
V1-10305	3.5mm straight plug, coil cord (30" extended length), black	\$ 47.44
V1-10433	3.5mm right angle plug, coil cord (30" extended length) black	\$ 47.44

**CONSULT TABLE OF CONTENTS FOR REPLACEMENT PARTS & ADDITIONAL EAR INSERT OPTIONS**

**CONTACT FACTORY FOR ALL INTRINSICALLY SAFE APPROVED PRODUCTS**

# Vertex/Yaesu

**VX-210, VX-210A, VX-400, VX-131  
VX-160, VX-180, VX-410, VX-420,**

3.5MM Right Angle Connector with 1 Locking Screw



PART NUMBER	DESCRIPTION	SUGGESTED RESALE
-------------	-------------	---------------------

### SURVEILLANCE KITS

V1-10654	1 Wire Earphone Kit <b>Black (Receive only no transmit)</b>	\$ 55.01
V1-10617	2 Wire Palm Microphone Kit <b>Black</b>	\$ 87.89
V1-10727	2 Wire Palm Microphone Kit <b>Beige</b>	\$ 87.89
V1-10618	3 Wire Mini Lapel Microphone Kit <b>Black</b>	\$ 162.96
V1-10736	3 Wire Mini Lapel Microphone Kit <b>Beige</b>	\$ 162.96

### EAR INSERT OPTIONS *Consult table of contents for additional Ear Insert Options*

C800947	Regular Clear Ear Tip	\$ 1.06
C100733	Noise Attenuating Plugs ( <b>NRR 25dB</b> )	\$ 2.33
C806573-LM	Flexible Open Ear Inserts Left, Medium	\$ 15.38
C806573-RM	Flexible Open Ear Inserts Right, Medium	\$ 15.38

### WIRELESS ACCESSORIES FOR USE WITH SURVEILLANCE KITS

V1-10610	Wireless Ear Receiver used with Flat Pack Inductor or Neckloop (Conventional Version)	\$ 202.44
V1-10611	Wireless Ear Receiver used with Flat Pack Inductor or Neckloop (Squelched Version)	\$ 260.86
V1-10471	Flat Pack Inductor with 2 prong jack for use with existing 2 & 3 Wire Kits	\$ 70.73
V1-10666	28" Universal neck loop	\$ 70.73
V1-10603	49" Universal neck loop	\$ 80.98
C819021	Replacement batteries (4) for Wireless Ear Receiver	\$ 11.26
C101114	Wax Trap (15) and Installation Tool (Replacement Part for Wireless Ear Receiver)	\$ 18.96

### HEADSETS

V4-EX2VD5	Explorer, lightweight, flexible earloop, w/ boom mic, quick-disconnect acoustic tube, mini PTT	\$ 73.13
V4-BA2VD1	Breeze, lightweight, behind-the-head, single spkr with standard PTT	\$ 77.66
* V4-BA2VD3B	Breeze, lightweight, behind-the-head, single spkr w/std. PTT & 2.5mm pigtail for remote PTT	\$ 86.06
V4-10407	Lightweight Single Speaker Padded Headband with standard PTT	\$ 102.15
V4-HC2VD5	Hurricane, lightweight, dual spkr, 21dB reduction, behind-the-head, with mini PTT	\$ 224.98
V4-NR2VD1	Ranger Single Speaker behind-the-head with standard PTT	\$ 306.48
V4-10404	Over-the-head Dual Speaker Heavy Duty with standard PTT	\$ 282.87
V4-10405	Behind-the-Head Dual Speaker Heavy Duty with standard PTT	\$ 331.76
V4-10406	ClearTRAK Behind-the-Head Dual Speaker Extreme Noise with Earcup PTT	\$ 395.37

### \* REMOTE PTT ACCESSORIES FOR BREEZE HEADSETS WITH 2.5MM JACK

V1-10513	Ring PTT with 2.5mm right angle plug, 5' straight cable	\$ 25.63
V1-10519	80mm Round Body PTT with 2.5mm right angle plug, coil cord	\$ 96.77

### SPEAKER MICROPHONES

V2-L2VD11	Profile Speaker Microphone with 2.5mm earphone jack	\$ 63.91
V2-10169	Evolution Speaker Mic with Coil cord, volume control and 2.5mm earphone jack	\$ 89.18

### EARPHONE KITS FOR USE WITH EVOLUTION AND PROFILE REMOTE SPEAKER MICROPHONES ONLY

V1-10282	2.5mm straight plug, coil cord (30" extended length), black	\$ 47.44
V1-10432	2.5mm right angle plug, coil cord (30" extended length), black	\$ 47.44
V1-EH22R131	2.5mm right angle plug, <b>Earhanger</b> , coil cord (30" extended length), black	\$ 26.93
V1-10305	3.5mm straight plug, coil cord (30" extended length), black	\$ 47.44
V1-10433	3.5mm right angle plug, coil cord (30" extended length) black	\$ 47.44

**CONSULT TABLE OF CONTENTS FOR REPLACEMENT PARTS & ADDITIONAL EAR INSERT OPTIONS  
CONTACT FACTORY FOR ALL INTRINSICALLY SAFE APPROVED PRODUCTS**

# Vertex/Yaesu

VX-200, VX-500, VX-510V, VX-510L

2.5mm/3.5mm Right Angle Connector



PART NUMBER	DESCRIPTION	SUGGESTED RESALE
-------------	-------------	---------------------

## SURVEILLANCE KITS

V1-10401	2 Wire Palm Microphone Kit <b>Black</b>	\$ 87.89
V1-10402	3 Wire Mini Lapel Microphone Kit <b>Black</b>	\$ 162.96

## EAR INSERT OPTIONS *Consult table of contents for additional Ear Insert Options*

C800947	Regular Clear Ear Tip	\$ 1.06
C100733	Noise Attenuating Plugs ( <b>NRR 25dB</b> )	\$ 2.33
C806573-LM	Flexible Open Ear Inserts Left, Medium	\$ 15.38
C806573-RM	Flexible Open Ear Inserts Right, Medium	\$ 15.38

## WIRELESS ACCESSORIES FOR USE WITH SURVEILLANCE KITS

V1-10610	Wireless Ear Receiver used with Flat Pack Inductor or Neckloop (Conventional Version)	\$ 202.44
V1-10611	Wireless Ear Receiver used with Flat Pack Inductor or Neckloop (Squelched Version)	\$ 260.86
V1-10471	Flat Pack Inductor with 2 prong jack for use with existing 2 & 3 Wire Kits	\$ 70.73
V1-10666	28" Universal neck loop	\$ 70.73
V1-10603	49" Universal neck loop	\$ 80.98
C819021	Replacement batteries (4) for Wireless Ear Receiver	\$ 11.26
C101114	Wax Trap (15) and Installation Tool (Replacement Part for Wireless Ear Receiver)	\$ 18.96

## HEADSETS

V4-BA2VB1	Breeze, lightweight, behind-the-head, single spkr with standard PTT	\$ 77.66
V4-10130	Lightweight Single Speaker Padded Headband with standard PTT	\$ 102.15
V4-10200	Over-the-head Dual Speaker Heavy Duty with standard PTT	\$ 282.87
V4-10201	Behind-the-Head Dual Speaker Heavy Duty with standard PTT	\$ 331.76

## SPEAKER MICROPHONES

V2-10086	Evolution Speaker Mic with Coil cord, volume control and 2.5mm earphone jack	\$ 89.18
----------	--	----------

## EARPHONE KITS FOR USE WITH EVOLUTION AND PROFILE REMOTE SPEAKER MICROPHONES ONLY

V1-10282	2.5mm straight plug, coil cord (30" extended length), black	\$ 47.44
V1-10432	2.5mm right angle plug, coil cord (30" extended length), black	\$ 47.44
V1-EH22R131	2.5mm right angle plug, <b>Earhanger</b> , coil cord (30" extended length), black	\$ 26.93
V1-10305	3.5mm straight plug, coil cord (30" extended length), black	\$ 47.44
V1-10433	3.5mm right angle plug, coil cord (30" extended length) black	\$ 47.44

## TACTICAL, FIRE, & HAZMAT COMMUNICATIONS EQUIPMENT

V1-T12VB117	Throat Microphone with Acoustic Tube & 80 MM PTT	\$ 526.85
-------------	--	-----------

**CONSULT TABLE OF CONTENTS FOR REPLACEMENT PARTS & ADDITIONAL EAR INSERT OPTIONS**

**CONTACT FACTORY FOR ALL INTRINSICALLY SAFE APPROVED PRODUCTS**



**VERTEX**  
**VX-530 and VX537**

Assembled Connector



PART NUMBER	DESCRIPTION	SUGGESTED RESALE
-------------	-------------	---------------------

**SURVEILLANCE KITS**

V1-10771	2 Wire Field <b>Repairable</b> Palm Microphone Kit <b>Black</b>	\$ 142.13
V1-10559	3 Wire Mini Lapel Microphone Kit <b>Black</b>	\$ 168.72

**EAR INSERT OPTIONS** *Consult table of contents for additional Ear Insert Options*

C800947	Regular Clear Ear Tip	\$ 1.06
C100733	Noise Attenuating Plugs ( <b>NRR 25dB</b> )	\$ 2.33
C806573-LM	Flexible Open Ear Inserts Left, Medium	\$ 15.38
C806573-RM	Flexible Open Ear Inserts Right, Medium	\$ 15.38

**WIRELESS ACCESSORIES FOR USE WITH SURVEILLANCE KITS**

V1-10610	Wireless Ear Receiver used with Flat Pack Inductor or Neckloop (Conventional Version)	\$ 202.44
V1-10611	Wireless Ear Receiver used with Flat Pack Inductor or Neckloop (Squelched Version)	\$ 260.86
V1-10471	Flat Pack Inductor with 2 prong jack for use with existing 2 & 3 Wire Kits	\$ 70.73
V1-10666	28" Universal neck loop	\$ 70.73
V1-10603	49" Universal neck loop	\$ 80.98
C819021	Replacement batteries (4) for Wireless Ear Receiver	\$ 11.26
C101114	Wax Trap (15) and Installation Tool (Replacement Part for Wireless Ear Receiver)	\$ 18.96

**HEADSETS**

V4-BA2VH1	Breeze, lightweight, behind-the-head, single spkr with standard PTT	\$ 90.39
V4-HC2VH1	Hurricane, lightweight, dual spkr, 21dB reduction, behind-the-head, with Std. PTT	\$ 239.98
V4-NR2VF1	Ranger Single Speaker behind-the-head with standard PTT	\$ 337.07
V4-10356	Over-the-head Dual Speaker Heavy Duty with standard PTT	\$ 326.65
V4-10489	ClearTRAK Behind-the-Head Dual Speaker Extreme Noise with Earcup PTT	\$ 415.87

**SPEAKER MICROPHONES**

V2-L2VH11	Profile Speaker Microphone with 2.5mm earphone jack	\$ 69.68
V2-10293	Evolution Speaker Mic with Coil cord, volume control and 2.5mm earphone jack	\$ 103.50
V2-G2VF211	Genesis with Coil Cord	\$ 130.00
V2-G2VF221	Genesis with Coil Cord and Emergency Button	\$ 147.06

**EARPHONE KITS FOR USE WITH EVOLUTION AND PROFILE REMOTE SPEAKER MICROPHONES ONLY**

V1-10282	2.5mm straight plug, coil cord (30" extended length), black	\$ 47.44
V1-10432	2.5mm right angle plug, coil cord (30" extended length), black	\$ 47.44
V1-EH22R131	2.5mm right angle plug, <b>Earhanger</b> , coil cord (30" extended length), black	\$ 26.93
V1-10305	3.5mm straight plug, coil cord (30" extended length), black	\$ 47.44
V1-10433	3.5mm right angle plug, coil cord (30" extended length) black	\$ 47.44

**TACTICAL, FIRE, & HAZMAT COMMUNICATIONS EQUIPMENT**

V1-T12VF137	Throat Microphone with Acoustic Tube & 80 MM PTT	\$ 470.48
-------------	--	-----------

**CONSULT TABLE OF CONTENTS FOR REPLACEMENT PARTS & ADDITIONAL EAR INSERT OPTIONS**  
**CONTACT FACTORY FOR ALL INTRINSICALLY SAFE APPROVED PRODUCTS**

**VERTEX/VAESU**

# Vertex/Yaesu

## VX-600, VX-800, VX-900

Assembled Connector



PART NUMBER	DESCRIPTION	SUGGESTED RESALE
-------------	-------------	---------------------

### SURVEILLANCE KITS

V1-10558	2 Wire Field <b>Repairable</b> Palm Microphone Kit <b>Black</b>	\$ 142.13
V1-10559	3 Wire Mini Lapel Microphone Kit <b>Black</b>	\$ 168.72

### EAR INSERT OPTIONS *Consult table of contents for additional Ear Insert Options*

C800947	Regular Clear Ear Tip	\$ 1.06
C100733	Noise Attenuating Plugs ( <b>NRR 25dB</b> )	\$ 2.33
C806573-LM	Flexible Open Ear Inserts Left, Medium	\$ 15.38
C806573-RM	Flexible Open Ear Inserts Right, Medium	\$ 15.38

### WIRELESS ACCESSORIES FOR USE WITH SURVEILLANCE KITS

V1-10610	Wireless Ear Receiver used with Flat Pack Inductor or Neckloop (Conventional Version)	\$ 202.44
V1-10611	Wireless Ear Receiver used with Flat Pack Inductor or Neckloop (Squelched Version)	\$ 260.86
V1-10471	Flat Pack Inductor with 2 prong jack for use with existing 2 & 3 Wire Kits	\$ 70.73
V1-10666	28" Universal neck loop	\$ 70.73
V1-10603	49" Universal neck loop	\$ 80.98
C819021	Replacement batteries (4) for Wireless Ear Receiver	\$ 11.26
C101114	Wax Trap (15) and Installation Tool (Replacement Part for Wireless Ear Receiver)	\$ 18.96

### HEADSETS

V4-BA2VF1	Breeze, lightweight, behind-the-head, single spkr with standard PTT	\$ 90.39
V4-BA2VF3B	Breeze, lightweight, behind-the-head, single spkr w/std. PTT & 2.5mm pigtail for remote PTT	\$ 112.39
V4-HC2VF1	Hurricane, lightweight, dual spkr, 21dB reduction, behind-the-head, with Std. PTT	\$ 239.98
V4-NR2VF1	Ranger Single Speaker behind-the-head with standard PTT	\$ 337.07
V4-10356	Over-the-head Dual Speaker Heavy Duty with standard PTT	\$ 326.65
V4-10449	ClearTRAK Behind-the-Head Dual Speaker Extreme Noise with Earcup PTT	\$ 415.87

### SPEAKER MICROPHONES

V2-L2VF11	Profile Speaker Microphone with 2.5mm earphone jack	\$ 69.68
V2-10167	Evolution Speaker Mic with Coil cord, volume control and 2.5mm earphone jack	\$ 103.50
V2-G2VF211	Genesis with Coil Cord	\$ 130.00
V2-G2VF221	Genesis with Coil Cord and Emergency Button	\$ 147.06

### EARPHONE KITS FOR USE WITH EVOLUTION AND PROFILE SPEAKER MICROPHONES ONLY

V1-10282	2.5mm straight plug, coil cord (30" extended length), black	\$ 47.44
V1-10432	2.5mm right angle plug, coil cord (30" extended length), black	\$ 47.44
V1-EH22R131	2.5mm right angle plug, <b>Earhanger</b> , coil cord (30" extended length), black	\$ 26.93
V1-10305	3.5mm straight plug, coil cord (30" extended length), black	\$ 47.44
V1-10433	3.5mm right angle plug, coil cord (30" extended length) black	\$ 47.44

### TACTICAL, FIRE, & HAZMAT COMMUNICATIONS EQUIPMENT

V1-T12VF137	Throat Microphone with Acoustic Tube & 80 MM PTT	\$ 470.48
-------------	--	-----------

**CONSULT TABLE OF CONTENTS FOR REPLACEMENT PARTS & ADDITIONAL EAR INSERT OPTIONS**

**CONTACT FACTORY FOR ALL INTRINSICALLY SAFE APPROVED PRODUCTS**

## Miscellaneous Accessories and Special Application Items

PART NO.	DESCRIPTION	RADIO MODEL	SUGGESTED RESALE
<b>ACCESSORY CLAMPS FOR KENWOOD RADIOS</b>			
C100783	Accessory clamp for securing accessory into radio	TK-250/350/353 Series	\$ 6.11
C100784	Accessory clamp for securing accessory into radio	TK-260/270 and TK-360/370 Series	\$ 6.11
<i>Note: These are ONLY associated with Kenwood accessories purchased before January 31, 2000.</i>			
<b>ACCESSORY CLAMPS FOR VERTEX RADIOS</b>			
C101083	Accessory clamp for securing accessory into radio	VX-210, VX-400, VX410, VX-42	\$ 8.71
C402043	Accessory cable tie for securing accessory into radio	VX-10, VX-300, VXF-1	\$ 1.19
<b>ADAPTERS</b>			
<b>Motorola</b>			
V1-10335	Adapter for HT1000 radios to allow use of accessories utilizing 3.5mm threaded plug.	HT1000 Series (HT1000, MT2000, MTS2000, MTX8000 MTS838, MTX9000 and JT1000) XTS3000/Astro Transcript Stealth	\$ 51.25
<b>Kenwood</b>			
V1-10430	Adapter with TK480 style connector for receive only applications* *Use with standard earphone kits and ear receivers having a standard 2.5mm plug.	TK-480/481, TK-290/390/380	\$ 51.66
<b>Walkman Adapter</b>			
V1-10546	Adapter with 2 prong earphone jack and 3.5mm jack. Product allows use of Sony Walkman headset vs standard earpiece		\$ 41.00
<b>THROAT MICROPHONE</b>			
V1-10691	Throat Micorphone, quick disconnect acoustic tube with 6 pin Hirose		\$ 235.24
C760090	Replacement strap only for Throat Microphone		\$ 30.77
<b>CLOTHING CLIPS</b>			
C801665	Nickel plated steel garment clip with clear plastic snap-on strap		\$ 1.37
C760087	Black plastic barrel clip for wire kits, Explorer, Breeze or Hurricane <i>(Barrel clip cannot be used with larger cables)</i>		\$ 1.37
<b>TRANSITION MODULE KITS</b>			
C100768	Kit includes case housings with clothing clip, strain reliefs, push-to-talk, generic pcb and wiring instructions	Headsets	\$ 21.01
C100769	Kit includes case housings with clothing clip, strain reliefs, generic pcb and wiring instructions	Surveillance Kits	\$ 28.98
<b>PROFILE BELT CLIP</b>			
C101076	Replacement belt clip for Profile only		\$ 7.62
<b>CELLULAR/iDEN ACCESSORIES</b>		<b>RADIO MODELS</b>	
V4-10360	Lightweight Single Spkr Hdst no PTT with 2.5mm right angle plug	i500 / i550 / i700 / i1000 (With Adapter NTN8654)	\$ 68.74
V4-BA2MN2	Breeze Behind the head single speaker with boom microphone and NO PTT with 2.5mm right angle plug	i280 / i370xl / i470 / 390 i600 / r300 / r370xl (With Adapter NTN8369)	\$ 33.48
V4-BA2MN2	Breeze Behind the head single speaker with boom microphone and NO PTT with 2.5mm right angle plug	r470 / fmr470 i500 / i550 / i700 / i1000 (With Adapter NTN8654)	\$ 33.48

*Note: Cellular accessories above may be compatible with other cellular phone platforms. Please consult original phone manufacturer. All accessories above have a 2.5mm right angle plug, which may require an accessory adapter depending on your phone model.*

# Dispatch Headsets

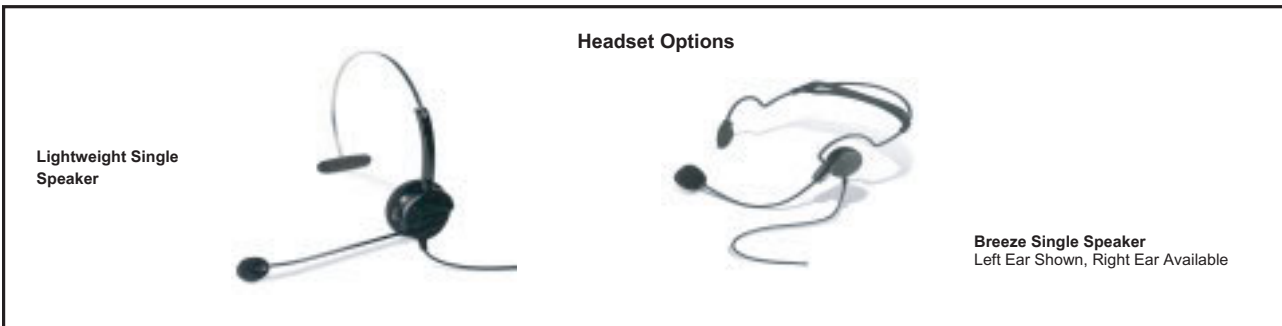
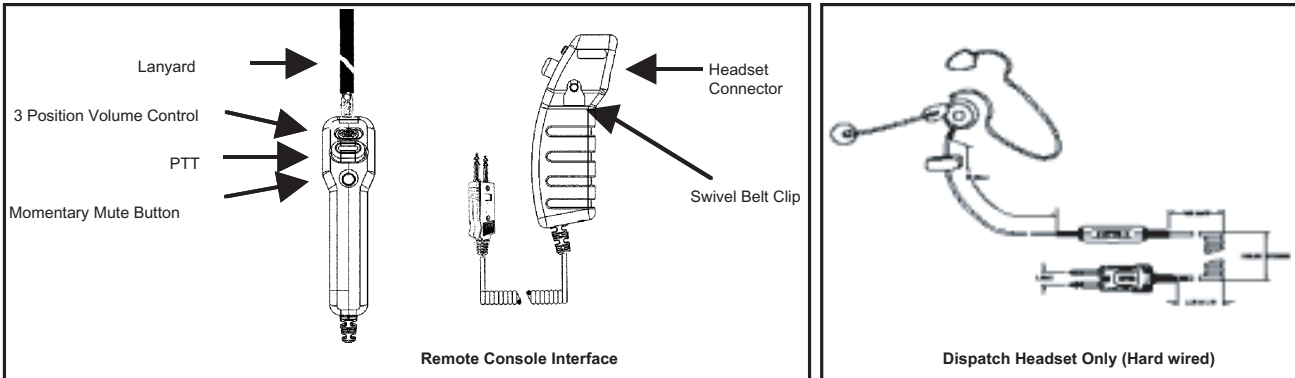

To meet users unique requirements, OTTO offers two different tiers for dispatch operations.

**Remote Console Interface:** For users who wish to activate radio PTT, mute and volume control *remotely* from the Dispatch Console. This is a **MODULAR** system and all components can easily be replaced or interchanged including control grip, headset options and 15' (extended) coil cord with two prong plug.

**Dispatch Headset Only:** For users who will typically *use the dispatch console* to activate radio PTT and volume control. This unit is a **hard wired unit** and includes headset with 15' (extended) coil cord and two prong plug. There are no interchangeable parts. There is not a remote PTT function on these headsets.

PART NUMBER	DESCRIPTION	SUGGESTED RESALE
-------------	-------------	------------------

**Remote Console Interface and Headset Options:**

V1-10664	Remote Console Interface with PTT, mute & volume control and 15' (extended) coil cord with two prong plug and lanyard	\$ 235.68
<b>Headset Options:</b>		
V4-BN2KA2	Breeze (Left Ear Only) behind the head headset with <b>noise canceling</b> microphone	\$ 64.85
V4-BR2KD2	Breeze (Right Ear Only) behind the head headset with <b>noise canceling</b> microphone	\$ 64.85
V4-VL2KD2	Lightweight, single speaker, over the head metal headband with <b>noise canceling</b> microphone	\$ 64.85

**Dispatch Headset Only- All units are hard wired. Coil cord is 15' extended.**

V4-BN2DP7	Breeze behind the head headset with noise canceling mic and coil cord with two-prong plug-Low Gain (Non-amplified)	\$ 188.65
V4-VL2DP7	Lightweight, single speaker over the head, metal headband with noise canceling mic and coil cord with two-prong plug-Low Gain (Non-amplified)	\$ 188.65

**Dispatch Accessories**

C740086	Lanyard, Black	\$ 8.15
C101224	Swivel Belt Clip	\$ 12.25
V3-10248	Replacement 15' (extended) coil cable with two prong plug	\$ 73.58

# Racing Communication System

PART NO.	CONNECTOR TYPE	RADIO MODELS	SUGGESTED RESALE
<b>Car Harness</b>			
VR30001	2.5/3.5mm Right Angle Overmolded Connector	TK-220/320, 240/340, 240D/340D TK-208/308, 430/431, 250/350/353 TK-260/270, 260G/360G, 360/370, 270G/370G, 248/348, 2100/3100 Pro-Talk, 3101 FreeTalk XL 2102/3102 Pro-Power	\$ 166.50
VR30002	2.5/3.5mm Right Angle	GP300 / SP50 / P110 / P1225/P1225LS P200 / LTS2000 / CT150 / CT250 CT450 / CT450LS / GP308	\$ 166.50
VR30003	2.5/3.5mm Right Angle	SP10 / SP21 / GT1 / XTN446 / XTN500 XTN600	\$ 166.50
VR30005	2.5/3.5mm Right Angle	SP120 / 130 / 140 / SL25 / SL55	\$ 166.50
VR30006	Single pin stereo right angle	SP200 / SP210 / SL100 and Legacy- PL1145 / PL2245 / PL2215P / PL2245P PL2415 / PL2445 / PL5161 / PL5164 <b>requires ACC-506 adapter</b>	\$ 166.50
VRCC0003	Adapter Cables required to adapt NASCAR Helmet Harness to Sports Car Harness		\$ 60.00

*Note: Contact OTTO Communications for other radio configurations available.*

<b>PTT Options</b>			
C201434		PTT Mounting Bracket Drilled	\$ 34.00
C201441		PTT Mounting Bracket Undrilled	\$ 34.00
U2-331		PTT Coil Cord Switch	\$ 80.00

<b>Helmet Kit</b>			
VR10001		Dual Acoustic Tube with Noise Attenuating Plugs, 250 Ohm Earphone and 3.5mm Mini Coil Cord to attach to Helmet Harness	\$ 85.00
VR20001		Boom Microphone	\$ 95.00
VR40001		Helmet Harness to attach Earphone Kit and Boom Microphone	\$ 75.00
VRCC0004		Adapter cable required to adapt Sports Car Helmet Harness to NASCAR Car Harness	\$ 60.00

<b>Remote Antennas</b>			
VRA0001	Formula Style (open car)	Thick Mount Antenna with Ground Plane and 3' cable	\$ 69.00
VRA0002	Sedan Style (closed car)	Thin Mount Antenna with 6' cable	\$ 60.00
VRA0003	Base Station	UHF Base Station Antenna with 35' cable and clamp (Mounting Pole Not Included)	\$ 235.00
C801080	Antenna Adapter	SMA to BNC Adapter	\$ 15.00

continued on page 62

# Racing Communication System

PART NO.	CONNECTOR TYPE	RADIO MODELS	SUGGESTED RESALE
----------	----------------	--------------	---------------------

### Radios

VRTK3101K	FreeTalk XL	Standard battery, charger, antenna and leather case	\$ 310.00
VRTK3100K2	ProTalk	Standard battery, charger, antenna and leather case	\$ 310.00
VRTK370GK	TK370 Programmable	Extended Battery, Rapid charger, antenna and leather case	\$ 635.00

### ClearTrak Behind-the-head Extreme Noise Canceling Headset

V4-10025	2.5/3.5mm Right Angle Overmolded Connector	TK-220/320, 240/340, 240D/340D TK-208/308, 430/431, 250/350/353 TK-260/270, 260G/360G, 360/370, 270G/370G, 248/348, 2100/3100 Pro-Talk, 3101 FreeTalk XL 2102/3102 Pro-Power	\$ 395.37
V4-10047	2.5/3.5mm Right Angle Overmolded Connector	GP300 / SP50 / P110 / P1225/P1225LS P200 / LTS2000 / CT150 / CT250 CT450 / CT450LS /GP308	\$ 395.37
V4-10368	2.5/3.5mm Right Angle Overmolded Connector	SP120 / 130 / 140 / SL25 / SL55	\$ 395.37
C101060	Antenna with clamp	Antenna with clamp to mount on Headset for extended range	\$ 74.25

### Spare Parts and Accessories

C101044	Pack of 10	Noise Attenuating Plugs with Tubes	\$ 10.25
C101045	Pack of 1	Acoustic Tube Assembly	\$ 15.38
C101115-2	Pack of 1	Black Dynamic Earphone	\$ 15.43
V3-10097		Coil Cord only with 3.5mm Straight Plug	\$ 21.73
C100930		Adapter with clothing clip for acoustic tube	\$ 11.46
VRCC001		Carry Case for Complete Race System	\$ 60.00
VRCC0005		OTTO Communications Racing Belt	\$ 15.00
C804111		Instruction Manual	No Charge

## 2 Wire Field Repairable Palm Mic Kits

Replacement parts are NOT plug and play.  
All components are available to be wired  
by your local qualified technician.

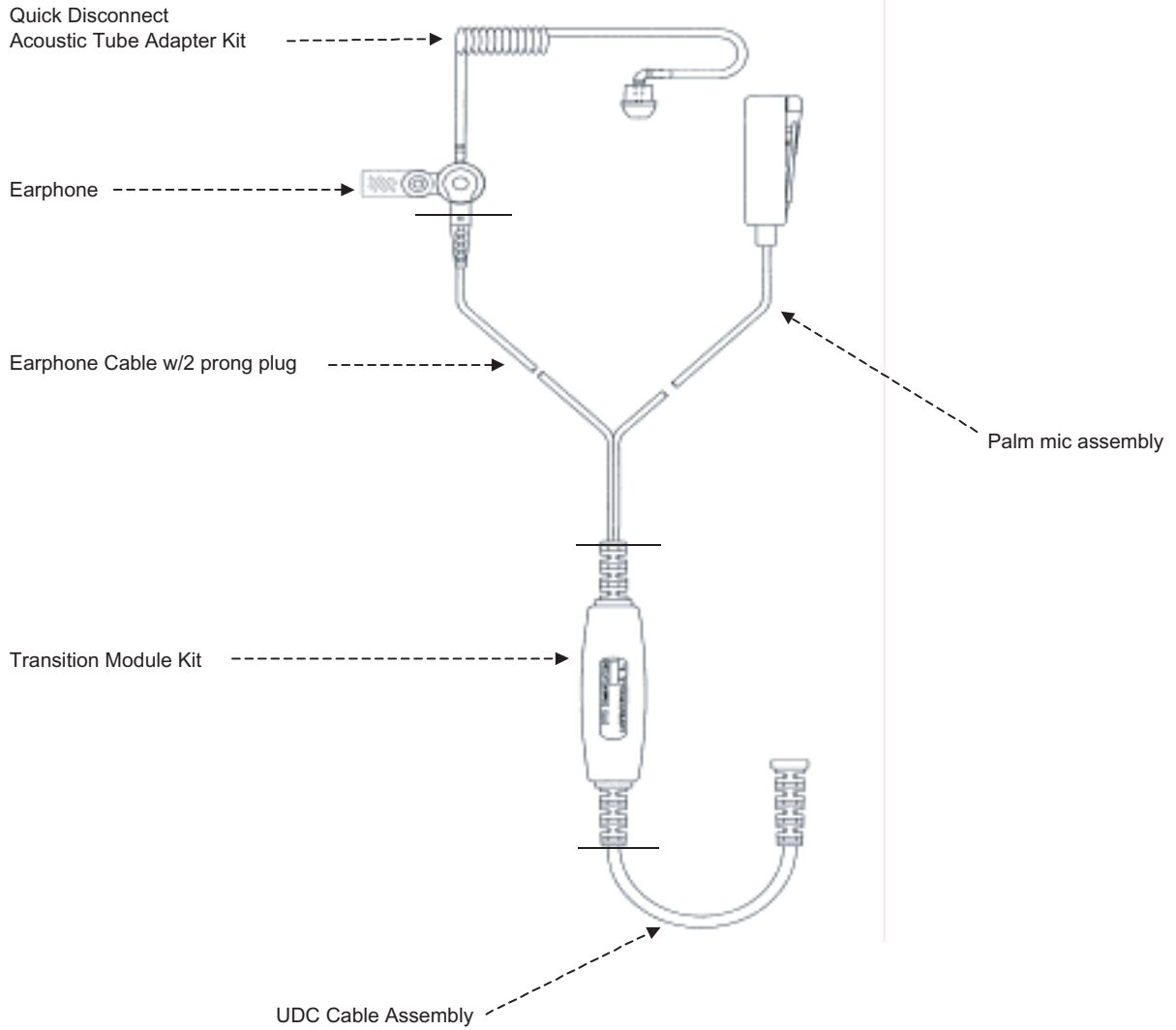

## 2 Wire Field Repairable Kits

PART NUMBER	DESCRIPTION	SUGGESTED RESALE
-------------	-------------	---------------------

<b>HT1000</b>		
XTS3000/Astro, HT1000 Series (HT1000, MT2000, MTX8000, MTX838, MTX9000 and JT1000 Radios), Transcript Stealth (All Require adapter V1-10335) Visar (Requires no adapter)		
V1-10337	2 Wire palm microphone kit	\$ 156.07
V1-10364	Replacement palm microphone assembly	\$ 45.69
V3-10069	Replacement UDC cable w/3.5mm threaded plug	\$ 31.06
C810173	Replacement PCB assembly	\$ 20.13
C100841	Transition module kit	\$ 28.98

<b>GP300</b>		
SP50 / GP300 / P110 / P1225 / GTX and GP350 (GP350 requires Motorola adapter HLN9482) (Tait Orca requires Tait TOPA-AA-005 adapter)		
V1-10338	2 Wire palm microphone kit	\$ 113.66
V1-10365	Replacement palm microphone assembly	\$ 45.69
V3-10072	Replacement UDC cable GP300 connector	\$ 31.06
C810170	Replacement PCB assembly	\$ 20.13
C100840	Transition module kit	\$ 28.98

<b>Kenwood</b>		
TK-220/320, 240/340, 240D/340D, 208/308, 430/431, TK-250/350/353, 260/270, 360/370, 248/348, TK-480,481, 290/390/380/280		
V1-10339	2 Wire palm microphone kit TK250 style connector	\$ 127.15
V1-10355	2 Wire palm microphone kit TK480 assembled connector	\$ 133.93
V3-10079	Replacement UDC cable TK250 Series connector	\$ 31.06
V3-10080	Replacement UDC cable TK480 Series connector	\$ 42.53
C810129	Replacement PCB assembly for TK480 Only	\$ 20.13
C100769	Transition module kit for TK480	\$ 28.99
C910075-2	Replacement earphone cable w/ 2 prong plug	\$ 22.84
V1-10366	Replacement palm microphone assembly	\$ 45.69
C810171	Replacement PCB assembly	\$ 20.13
C100842	Transition module kit	\$ 28.98

<b>M/A-COM</b>		
Assembled Connector MRK / Prism / MPA / PCS		
V1-10218	2 Wire palm microphone kit for MRK, Black	\$ 217.29
V1-10110	2 Wire palm microphone kit for MPA, Black	\$ 217.29
V1-10116	2 Wire palm microphone kit for PCS, Black	\$ 157.43
V1-10370	2 Wire palm microphone kit for PRISM, Black	\$ 217.29
V3-10186	Replacement UDC cable MRK connector	\$ 40.51
V3-10185	Replacement UDC cable Prism connector	\$ 40.51
V3-10188	Replacement UDC cable MPA connector	\$ 40.51
V3-10187	Replacement UDC cable PCS	\$ 40.51
C810358	Replacement PCB assembly MRK	\$ 20.13
C810158	Replacement PCB assembly MPA	\$ 20.13
C810358	Replacement PCB assembly Prism	\$ 20.13
C810150	Replacement PCB assembly PCS	\$ 20.13
C101050	Transition module kit MRK	\$ 28.99
C101052	Transition module kit PCS	\$ 28.99
C101051	Transition module kit MPA	\$ 28.99
C101203	Transition module kit Prism	\$ 28.99
V3-10259	Replacement earphone cable w/2 prong plug	\$ 13.97
V1-10562	Replacement palm microphone assembly	\$ 45.69



## 2 Wire Field Repairable Kits

PART NUMBER	DESCRIPTION	SUGGESTED RESALE
-------------	-------------	---------------------

<b>VERTEX</b>		
<b>Assembled Connector VX800</b>		
V1-10558	2 Wire palm microphone kit	\$ 142.13
C810315	Replacement PCB assembly	\$ 20.13
C101049	Transition module kit	\$ 28.98
V1-10675	Replacement palm microphone assembly	\$ 45.69
V3-10189	Replacement UDC cable VX800 connector	\$ 41.52
C910075-2	Replacement earphone cable w/2 prong plug, 39"	\$ 22.84

<b>REPLACEMENT PARTS UNIVERSAL TO ALL OF THE REPAIRABLE KITS.</b>		
C910075-2	Replacement earphone cable w/2 prong plug, 39"	\$ 22.84
C910265-2	Replacement earphone cable w/2 prong plug, 48"	\$ 23.84
C101115-2	Black, Dynamic earphone only	\$ 15.42
C800947	Regular eartip (1 per package)	\$ 1.06
C101221-2	Quick Disconnect Tube assembly, noise attenuating plugs	\$ 21.01
C100733	Noise Attenuating Plugs (One foam eartube plug and one foam earplug)	\$ 2.32
C101220-2	Black, Quick Disconnect Acoustic Tube Assembly, clear eartip	\$ 14.08

**CONSULT TABLE OF CONTENTS FOR EAR INSERT OPTIONS AND REPLACEMENT PARTS**

**CONTACT FACTORY FOR ALL INTRINSICALLY SAFE APPROVED PRODUCTS**

# Replacement Acoustic Tubes, Cables and Earphones

PART NUMBER	DESCRIPTION	SUGGESTED RESALE
-------------	-------------	---------------------

## RUBBER EARTIPS

C800947	Clear Regular Eartip (1 per package)	\$ 1.06
C100569	Clear Regular Eartips (10 per package)	\$ 9.89
C101206	Clear Regular Eartips (25 per package)	\$ 25.02
C101207	Clear Regular Eartips (100 per package)	\$ 90.09

## FLEXIBLE OPEN EAR INSERTS

C806573-LS	Left ear, small	\$ 15.38
C806573-LM	Left ear, medium (Recommended size - fits most people)	\$ 15.38
C806573-LL	Left ear, large	\$ 15.38
C806573-RS	Right ear, small	\$ 15.38
C806573-RM	Right ear, medium (Recommended size - fits most people)	\$ 15.38
C806573-RL	Right ear, large	\$ 15.38

## NOISE ATTENUATION KITS (NRR 25dB)

C101221-2	Black Quick Disconnect Acoustic Tube Assembly, Noise Attenuating Plugs, (Kit includes acoustic tube, adapter w/clip, foam eartube plug, and foam earplug)	\$ 21.01
C101221-19	Beige Quick Disconnect Acoustic Tube Assembly, Noise Attenuating Plugs, (Kit includes acoustic tube, adapter w/clip, foam eartube plug, and foam earplug)	\$ 21.01
C100733	Replacement Noise Attenuating Plugs (One foam eartube plug and one foam earplug for above)	\$ 2.32
C807010-1K	Replacement Noise Attenuating Plugs (Bag of 1000 foam plugs with black tube)	\$ 396.23
C807010-5K	Replacement Noise Attenuating Plugs (Bag of 5000 foam plugs with black tube)	\$ 1,828.94

## REPLACEMENT EARPHONES FOR SURVEILLANCE KITS

C101219-2	Black, Quick Disconnect, w/Dynamic earphone, clear eartip	\$ 30.49
C101219-19	Beige, Quick Disconnect, w/Dynamic earphone, clear eartip	\$ 30.49
C101220-2	Black, Quick Disconnect acoustic tube assembly, clear eartip	\$ 21.01
C101220-19	Beige, Quick Disconnect acoustic tube assembly, clear eartip	\$ 21.01
C101222-2	Black, Quick Disconnect adapter w/cable clip and clothing clip	\$ 14.08
C101222-19	Beige, Quick Disconnect adapter w/cable clip and clothing clip	\$ 14.08
C101199	Quick Disconnect acoustic tube and clear eartip (1 per pack)	\$ 7.74
C101199-05	Quick Disconnect acoustic tube and clear eartip (5 per pack)	\$ 30.03
C101115-2	Black, Dynamic earphone only	\$ 15.43
C101115-19	Beige, Dynamic earphone only	\$ 15.43

## REPLACEMENT CABLES FOR EARPHONE KITS

V3-10096	2.5mm straight plug, coil cord (30" extended length), black, with overmolded pins	\$ 22.82
V3-10107	2.5mm right angle plug, coil cord (30" extended length), black, with overmolded pins	\$ 22.82
V3-10108	3.5mm right angle plug, coil cord (30" extended length), black with overmolded pins	\$ 22.82
C910107-2	3.5mm thread plug, straight (48 inches), black with overmolded pins	\$ 35.51

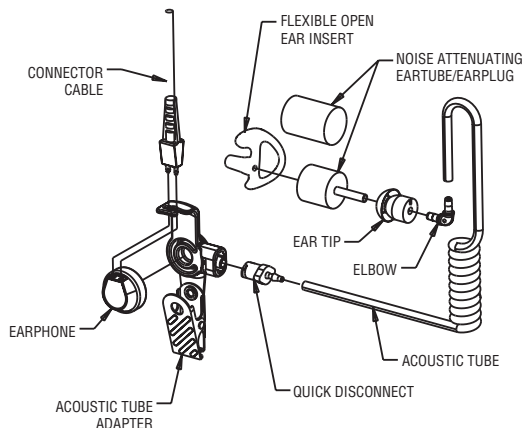

Note: Select one ear insert option to attach to elbow: Flexible Open Ear Insert or Noise Attenuating Plugs or Eartip

## Replacement Parts-Headsets

PART NUMBER	DESCRIPTION	SUGGESTED RESALE
<b>REPLACEMENT PARTS FOR NOISE CANCELING HEAVY DUTY HEADSETS</b>		
C101333	Speaker element (1 per package)	\$ 28.46
C807009-02	Earseal cushions (2 per package)	\$ 26.78
C760070	Foam Speaker Covers ( To be used over speaker, 2 per package)	\$ 3.87
C807008-02	Cloth covers for earseals (2 per package)	\$ 6.40
C760004	Adjustable head strap (1 per package)	\$ 25.02
C100761-05	Knurled boom screws (5 per package)	\$ 18.63
C100762-05	C-clip retainer for headband attachment (5 per package)	\$ 19.99
C740071-10	E- Style Retaining Ring	\$ 2.61
C807007-05	Mic windscreen (5 per package)	\$ 13.39
C807006-05	O-ring to secure windscreen (5 per package)	\$ 1.45
C100997	Boom mic screw to hold boom mic to earcup	\$ 27.04
C816020	Boom mic assembly	\$ 131.74
C910336	Boom mic cable with connector	\$ 24.09
C701156-02	Mic element screw (2 per package)	\$ 2.82
C701156-10	Mic element screw (10 per package)	\$ 9.99
C816028	Mic element with cartridge - standard (approx. 3dB)	\$ 80.61
C816041*	Mic element with cartridge - extreme high noise (approx. 19 dB)	\$ 119.22
*The extreme high noise mic is avail. as a repl. item <u>only for these headsets - it is not an upgrade option</u> and the old mic is non-returnable.		
<b>REPLACEMENT PARTS FOR HURRICANE HEADSETS</b>		
C807055-05	Mic windscreen (5 per package)	\$ 5.82
C807107	Temple Pad	\$ 5.48
C101205	Acoustic Tube Assembly (2 per package)	\$ 3.74
C402395-02	Barbed Coupler For Attaching Acoustic Tube On To Hurricane	\$ 2.00
C100870-05	Clothing clip (5 per package)	\$ 4.31
C101041	Noise Attenuating Plugs with Tube (2 per package)	\$ 2.53
C100569	Clear Regular Eartips (10 per package)	\$ 9.89
C806573-LM	Flexible Open Ear Insert, Left ear medium	\$ 15.38
C806573-RM	Flexible Open Ear Insert, Right ear medium	\$ 15.38
C101268	Noise Attenuating Plugs with Tube (24 per package)	\$ 28.36
* NOTE: FOR MORE REPLACEMENT EARPHONE OPTIONS, SEE PAGE 59		
<b>REPLACEMENT PARTS FOR RANGER HEADSETS</b>		
C807073-05	Mic windscreen (5 per package)	\$ 5.82
C807098-05	Ear speaker cover (5 per package)	\$ 5.82
<b>REPLACEMENT PARTS FOR LIGHTWEIGHT HEADSETS WITH PADDED BAND</b>		
C807027-05	Mic windscreen (5 per package)	\$ 5.82
C807074-02	Cloth covers for speaker pads (2 per package)	\$ 4.31
C807028-02	Foam Speaker Pad (2 per package)	\$ 4.66
C101073	Square plastic slide ring plus screw	\$ 1.82
C101074	Square plastic slide ring plus screw and TBAR for right side	\$ 4.68
C100112	Hanger Only	\$ 6.46
C101075	Square plastic slide ring, hanger & adjustable slide plate for leftside	\$ 9.11
<b>REPLACEMENT PARTS FOR BREEZE HEADSETS</b>		
C807055-05	Mic windscreen (5 per package)	\$ 5.82
C100870-05	Clothing clip (5 per package)	\$ 4.31
C807057-05	Earpads (5 per package)	\$ 4.46
C807058-05	Temple pads for Breeze headsets (5 per package)	\$ 4.46
C101225	Plastic disk with tape and cloth cover (1 each)	\$ 4.46
C800969-05	Cloth cover used only with C101225 (5 per pack)	\$ 4.89
<b>REPLACEMENT PARTS FOR EXPLORER HEADSETS</b>		
C101180	Acoustic Tube with elbow (1 per package)	\$ 2.82
C101180-05	Acoustic Tube with elbow (5 per package)	\$ 13.31
C100870-05	Clothing clip (5 per package)	\$ 4.31
C807148-05	O-ring to secure windscreen (5 per package)	\$ 3.46
C807017-05	Microphone Windscreens (5 per package)	\$ 3.98
<b>REPLACEMENT PART FOR 2 WIRE EARBUD PALM MICROPHONE</b>		
C801601-10	Earbud foam covers (10 per package)	\$ 6.40
<b>REPLACEMENT PART FOR 80MM PTT</b>		
C401868	Belt clip with "C" clamp and pin only	\$ 9.52

## Replacement Cable Assemblies for Headsets

PART NUMBER	DESCRIPTION	SUGGESTED RESALE
-------------	-------------	------------------

### Replacement straight UDC cables available for headsets with standard in-line ptt ONLY.

V3-10069	UDC cable - 12" straight w/strain relief and 3.5mm threaded connector for HT1000 Series	\$ 31.06
V3-10070	UDC cable - 12" straight w/strain relief and 6 pin Hirose connector for HT600/Saber/Astro	\$ 52.61
V3-10071	UDC cable - 12" straight w/strain relief and 2 pin right angle overmolded SP10 connector	\$ 31.06
V3-10072	UDC cable - 12" straight w/strain relief and 2 pin right angle overmolded GP300 connector	\$ 31.06
V3-10251	UDC cable - 12" straight w/strain relief and assembled HT1250/HT1550 Connector	\$ 31.06
V3-10073	UDC cable - 12" straight w/strain relief and 6 pin Hirose connector for Monogram/Maxon	\$ 50.10
V3-10074	UDC cable - 12"straight w/strain relief and assembled MPA connector	\$ 50.93
V3-10075	UDC cable - 12" straight w/strain relief and assembled MRK connector	\$ 62.02
V3-10076	UDC cable - 12" straight w/strain relief and assembled Prism/LPE connector	\$ 62.02
V3-10077	UDC cable - 12" straight w/strain relief and assembled PCS connector	\$ 50.93
V3-10078	UDC cable - 12" straight w/strain relief and assembled KPC / Panther 500P connector	\$ 50.10
V3-10207	UDC cable - 12" straight w/strain relief and assembled EDACS 300P connector	\$ 62.02
V3-10201	UDC cable - 12" straight w/strain relief and assembled Jaguar 700P connector	\$ 62.02
V3-10204	UDC cable - 12" straight w/strain relief and 2 pin right angle overmolded Panther 300P connector	\$ 29.58
V3-10110	UDC cable - 12" straight w/strain relief and 2 pin right angle overmolded NPC connector	\$ 29.58
V3-10079	UDC cable - 12" straight w/strain relief and 2 pin right angle overmolded Kenwood TK250 connector	\$ 31.06
V3-10045	UDC cable - 48" straight w/strain relief and 2 pin right angle overmolded KenwoodTK250	\$ 75.37
V3-10080	UDC cable - 12" straight w/strain relief and assembled Kenwood TK480 style connector	\$ 56.61
V3-10081	UDC cable - 12" straight w/strain relief and assembled Bendix King connector	\$ 58.43
V3-10083	UDC cable - 12" straight w/strain relief and 2 pin right angle overmolded Maxon SP120 connector	\$ 31.06
V3-10088	UDC cable - 12" straight w/strain relief and 2 pin straight overmolded ICOM F3/F4 connector	\$ 31.06
V3-10217	UDC cable - 12" straight w/strain relief and assembled ICOM F30G/F40G Connector	\$ 41.00
V3-10087	UDC cable - 12" straight w/strain relief and single stereo pin overmolded Vertex VX10 connector	\$ 31.06
V3-10254	UDC cable - 12" straight w/strain relief and assembled Vertex VX800 connector	\$ 50.93
V3-10228	UDC cable - 12" straight w/strain relief and 3.5mm Right Angle with 1 Locking Screw VX-210 / VX-400	\$ 31.06
V3-10083	UDC cable - 12" straight w/strain relief and 2 pin right angle overmolded Vertex VX500 connector	\$ 31.06
V3-10218	UDC cable - 12" straight w/strain relief and 2 pin straight overmolded ICOM F3G/F4G connector	\$ 31.06
V3-10347	UDC cable - 12" straight w/strain relief and 2 pin straight overmolded ICOM F50/F60 connector	\$ 45.00
V3-10358	UDC cable - 12" straight w/strain relief and 2 pin straight overmolded ICOM F11/F33GS connector	\$ 41.00

### Replacement straight cables for headsets WITHOUT in-line ptt.

V3-10059	UDC cable - 44" straight, 2 pin right angle overmolded GP300 connector, unterminated at other end.	\$ 32.30
V3-10252	UDC cable - 44" straight, HT1250/HT1550 assembled connector, unterminated at other end.	\$ 37.42
V3-10172	UDC cable - 48" straight, 2 pin right angle overmolded TK250 connector, unterminated at other end.	\$ 31.06

### Replacement coiled UDC cables available for select headsets with standard in-line ptt ONLY.

V3-10150	UDC cable - 5" coiled, w/strain relief and 2 pin right angle overmolded GP300 connector	\$ 31.06
V3-10156	UDC cable - 5" coiled, w/strain relief and 2 pin right angle overmolded SP10 connector	\$ 31.06
V3-10151	UDC cable - 10" coiled, w/strain relief and 3.5mm threaded connector for HT1000 series.	\$ 31.06
V3-10157	UDC cable - 5" coiled, w/strain relief and 6 pin Hirose connector for HT600/Saber/Astro series.	\$ 52.61
V3-10154	UDC cable - 5" coiled, w/strain relief and 2 pin right angle overmolded Kenwood TK250 connector	\$ 31.06
V3-10155	UDC cable - 10" coiled, w/strain relief and assembled Kenwood TK480 connector	\$ 56.61
V3-10152	UDC cable -10" coiled, w/strain relief MRK connector	\$ 62.02
V3-10209	UDC cable - 5" coiled, w/strain relief and EDACS connector	\$ 65.71
V3-10202	UDC cable - 10" coiled, w/strain relief and Jaguar 700P connector	\$ 62.02
V3-10220	UDC cable - 5" coiled, w/strain relief and Icom F3G,F4G,F4GS connector	\$ 31.06
V3-10221	UDC cable - 5" coiled, w/strain relief and Icom F30G/F40G connector	\$ 41.00
V3-10359	UDC cable - 5" coiled, w/strain relief and Icom F11,F21,F43GT connector	\$ 41.00
V3-10205	UDC cable - 5" coiled, w/strain relief and 2 pin right angle overmolded Panther 300P connector	\$ 29.58
V3-10153	UDC cable -10" coiled, w/strain relief and Prism/LPE connector	\$ 62.02
V3-10241	UDC cable -10" coiled, w/strain relief and VX-10,VX-300 connector	\$ 36.51

## Replacement Cable Assemblies for Headsets

PART NUMBER	DESCRIPTION	SUGGESTED RESALE
<b>Replacement 17" coiled (6' extended) UDC cables available for select headsets with EARCUP PTT</b>		
V3-10191	UDC cable - 17" coiled, w/strain relief and assembled MRK connector	\$ 67.21
V3-10203	UDC cable - 17" coiled, w/strain relief and assembled Jaguar 700P connector	\$ 67.21
V3-10206	UDC cable - 17" coiled, w/strain relief and 2 pin right angle overmolded Panther 300P connector	\$ 34.77
V3-10193	UDC cable - 17" coiled, w/strain relief and 2 pin right angle overmolded Kenwood TK250 connector	\$ 36.51
V3-10213	UDC cable - 17" coiled, w/strain relief and 2 pin right angle overmolded Maxon SP120 connector	\$ 36.51
V3-10214	UDC cable - 17" coiled, w/strain relief and single pin stero for Maxon SP200 / SP210	\$ 36.51
V3-10194	UDC cable - 17" coiled, w/strain relief and 2 pin right angle overmolded GP300 connector	\$ 36.51
V3-10192	UDC cable - 17" coiled, w/strain relief and 3.5mm threaded connector for HT1000 series	\$ 36.51
V3-10229	UDC cable - 17" coiled, w/strain relief and 3.5mm Right Angle with 1 Locking Screw VX-210 / VX-400	\$ 36.51
V3-10211	UDC cable - 17" coiled, w/strain relief and single pin stero right angle for Vertex VX-10 Series connector	\$ 36.51

## Evolution Speaker Microphone Replacement Parts

Speaker Microphone Model	Front Housing Assembly	Back Cover Assembly	Speaker Assembly	Mic and Mic Holder	Earphone Jack	Earphone Jack Cover (10 per bag)	PCB	Volume Control Knob (10 per bag)	Thumbscrew	Cable Assembly
ICOM F3,F3S,F4,F4S, Standard (V2-10083)	C100787	C100800	C100775	C100751	C100748	C401401-10	C101252	C100754	N/A	V3-10084
ICOM F3G,F3GS,F4G, F4GS (V2-10200)	C100787	C100800	C100775	C100751	C100748	C401401-10	C101252	C100754	N/A	V3-10262
ICOM F30G, F40G Standard (V2-10162)	C100787	C100800	C100775	C100751	C100748	C401401-10	C101252	C100754	C302400	V3-10216
ICOM F11,F21,F33GS,F43TR (V2-10288)	C100787	C100800	C100775	C100751	C100748	C401401-10	C101252	C100754	C303211	V3-10357
ICOM F50/F60 Standard (V2-10274)	C100787	C100800	C100775	C100751	C100748	C401401-10	C101365	C100754	C302400	V3-10346
Kenwood TK250 Standard (V2-10030)	C100787	C100800	C100775	C100751	C100748	C401401-10	C100803	C100754	N/A	V3-10040
Kenwood TK480 Standard (V2-10068)	C100787	C100800	C100838	C100751	C100748	C401401-10	C100758	C100754	C303175	V3-10082
Kenwood TK480 Coil Coax Cbl, Emg Btn & antenna port (V2-10112)	C101212	C100800	C100838	C100751	C100748	C401401-10	C101186	C100754	C303175	V3-10276
Kenwood TK480 Coil Coax Cbl & Volume Control (V2-10241)	TBD	C100800	C100838	C100751	C100748	C401401-10	TBD	C100754	C303175	V3-10310
Kenwood TK480 Special Hi/lo Switch (V2-10168)	C100787	C100800	C100838	C100751	C100748	C401401-10	C101187	C101184	C303175	V3-10082
M/A-COM EDACS 300 P Standard (V2-10158)	C100785	C100800	C100838	C100804	C100748	C401401-10	C101189	C100754	C101084	V3-10209
M/A-COM KPC /Panther 500P Standard (V2-10044)	C100787	C100800	C100839	C100804	C100748	C401401-10	C100758	C100754	C101028	V3-10027
M/A-COM Jaguar 700P Emg.Btn (V2-10154)	C100785	C100800	C100838	C100751	C100748	C401401-10	C100753	C100754	C101250	V3-10198
M/A-COM Jaguar 700P Str. Coax Cbl, Emg Btn & antenna port (V2-10155)	C100786	C100800	C100838	C100751	C100748	C401401-10	C100753	C100754	C101250	V3-10199
M/A-COM Jaguar 700P Coil Coax Cbl, Emg Btn & antenna port (V2-10156)	C100786	C100800	C100838	C100751	C100748	C401401-10	C100753	C100754	C101250	V3-10200
M/A-COM Monogram Standard (V2-10032)	C100787	C100800	C100775	C100751	C100748	C401401-10	C100774	C100754	N/A	V3-10032
M/A-COM NPC Standard (V2-10053)	C100787	C100800	C100838	C100751	C100748	C401401-10	C100758	C100754	N/A	V3-10033
M/A-COM PCS Standard (V2-10045)	C100787	C100800	C100838	C100751	C100748	C401401-10	C100758	C100754	C100652	V3-10026
M/A-COM MPA/MPD Standard (V2-10048)	C100785	C100800	C100838	C100751	C100748	C401401-10	C100756	C100754	C100651	V3-10024
M/A-COM MPA/MPD Str.Coax Cable, Emg Btn & antenna port (V2-10049)	C100786	C100800	C100838	C100751	C100748	C401401-10	C100756	C100754	C100651	V3-10025
M/A-COM MPA/MPD Coil Coax Cbl, Emg Btn & anenna port (V2-10166)	C100786	C100800	C100838	C100751	C100748	C401401-10	C100756	C100754	C100651	V3-10278
M/A-COM MRK Standard (V2-10046)	C100785	C100800	C100838	C100751	C100748	C401401-10	C101188	C100754	C100649	V3-10022
M/A-COM MRK Water Resistant Grill (V2-10105)	C101192	C100800	C100838	C100751	N/A	N/A	C101191	N/A	C100649	V3-10104
M/A-COM MRK Str. Coax Cbl, Emg Btn & antenna port (V2-10047)	C100786	C100800	C100838	C100751	C100748	C401401-10	C101188	C100754	C100649	V3-10023
M/A-COM MRK Coil Coax Cbl & Emg Btn (V2-10102)	C100786	C100800	C100838	C100751	C100748	C401401-10	C101188	C100754	C100649	V3-10237
M/A-COM Prism Standard (V2-10069)	C100785	C100800	C100838	C100751	C100748	C401401-10	C100753	C100754	C100649	V3-10061
M/A-COM Prism Str. Coax Cbl, Emg Btn & antenna port (V2-10070)	C100786	C100800	C100838	C100751	C100748	C401401-10	C100753	C100754	C100649	V3-10062

## Evolution Speaker Microphone Replacement Parts

Speaker Microphone Model	Front Housing Assembly	Back Cover Assembly	Speaker Assembly	Mic and Mic Holder	Earphone Jack	Earphone Jack Cover (10 per bag)	PCB	Volume Control Knob (10 per bag)	Thumbscrew	Cable Assembly
M/A-COM Prism Coil Cbl, Emg Btn & antenna port (V2-10107)	C100786	C100800	C100838	C100751	C100748	C401401-10	C100753	C100754	C100649	V3-10244
Maxon SP120/130/140 Standard (V2-10071)	C100787	C100800	C100775	C100751	C100748	C401401-10	C100758	C100754	N/A	V3-10046
Maxon SP200/210 Standard (V2-10157)	C100787	C100800	C100775	C100751	C100748	C401401-10	TBD	C100754	C302370	V3-10282
Maxon SP-2550/2850 SL-70W/EP-4800 Standard (V2-10032)	C100787	C100800	C100775	C100751	C100748	C401401-10	C100774	C100754	N/A	V3-10032
Motorola GP300 Standard (V2-10026)	C100787	C100800	C100838	C100751	C100748	C401401-10	C100758	C100754	N/A	V3-10039
Motorola HT750/HT1250 Standard (V2-10228)	C100787	C100800	C100838	C100751	C100748	C401401-10	C100758	C100754	C302551	V3-10253
Motorola HT1000 Standard (V2-10031)	C100787	C100800	C100839	C100751	C100748	C401401-10	C100758	C100754	N/A	V3-10043
Motorola HT1000 Standard & Emerg. Button (V2-10173)	C100785	C100800	C100839	C100751	C100748	C401401-10	C101185	C100754	N/A	V3-10283
Motorola HT1000 Special Hi/Lo Switch (V2-10074)	C100787	C100800	C100839	C100751	C100748	C401401-10	C101187	C101184	N/A	V3-10043
Motorola HT1000 Straight Coax Cable and antenna port (V2-10023)	C101193	C100800	C100839	C100751	C100748	C401401-10	C100758	C100754	N/A	V3-10274
Motorola HT1000 Coil Coax Cable & antenna port (V2-10139)	C101193	C100800	C100839	C100751	C100748	C401401-10	C100758	C100754	N/A	V3-10275
Motorola HT1000 Coiled Coax Cable, Emg Btn & antenna (V2-10202)	C100786	C100800	C100839	C100751	C100748	C401401-10	C101185	C100754	N/A	V3-10284
Motorola Saber / Astro Standard (V2-10024)	C100787	C100800	C100839	C100751	C100748	C401401-10	C101247	C100754	C101248	V3-10288
Relm Wireless Standard (V2-10029)	C100787	C100800	C100775	C100751	C100748	C401401-10	C100803	C100754	N/A	V3-10044
TAIT/Orca Standard (V2-10026)	C100787	C100800	C100838	C100751	C100748	C401401-10	C100758	C100754	N/A	V3-10039
Vertex VX10, VX300, VXF-1 Standard (V2-10106)	C100787	C100800	C100775	C100751	C100748	C401401-10	C101251	C100754	N/A	V3-10086
Vertex VX210 / VX400 Standard (V2-10169)	C100787	C100800	C100775	C100751	C100748	C401401-10	C101251	C100754	N/A	V3-10230
Vertex VX500, VX510, VX200 Standard (V2-10086)	C100787	C100800	C100775	C100751	C100748	C401401-10	C100758	C101251	N/A	V3-10046
Vertex VX800/VX900 Standard (V2-10167)	C100787	C100800	C100838	C100751	C100748	C401401-10	C101249	C100754	C705007-02	V3-10277

Pricing for Evolution Remote Speaker Microphone Replacement Parts

PART NUMBER	DESCRIPTION	SUGGESTED RESALE
C100649	Thumbscrew, MRK	\$ 5.24
C100651	Thumbscrew, MPA	\$ 4.37
C100652	Thumbscrew, PCS	\$ 4.95
C100748	Earphone jack	\$ 2.62
C100750	Speaker assembly, 16 ohm	\$ 6.69
C100751	Mic/Mic Holder	\$ 5.53
C100753	PCB	\$ 23.28
C100754	Volume control (black) knob with o-ring (10 per bag)	\$ 8.83
C100756	PCB	\$ 23.86
C100758	PCB	\$ 8.15
C100774	PCB	\$ 25.61
C100775	Speaker assembly, 8ohm	\$ 5.53
C100785	Front Housing with parts	\$ 17.17
C100786	Front Housing with parts	\$ 26.78
C100787	Front Housing with parts	\$ 15.71
C100800	Back Cover/Speaker Pad	\$ 16.59
C100803	PCB	\$ 23.86
C100804	Mic/Mic Holder	\$ 6.11
C100838	Speaker assembly, 16 ohm	\$ 6.69
C100839	Speaker assembly, 24 ohm	\$ 6.69
C101028	Thumbscrew, KPC (UDC with Pins)	\$ 5.24
C101028	Thumbscrew, KPC/Panther 500P (UDC with Pogo Pins)	\$ 5.24
C101084	Thumbscrew EDACS	\$ 7.51
C101184	Volume control (Gray) Knobs with o-ring (10 per bag)	\$ 8.83
C101185	PCB	\$ 23.28
C101186	PCB	\$ 20.36
C101187	PCB	\$ 23.28
C101188	PCB	\$ 24.48
C101189	PCB	\$ 20.36
C101191	PCB M/A Com used on V2-10105 only	\$ 23.28
C101192	Front Housing with parts	\$ 15.71
C101193	Front Housing with parts	\$ 26.77
C101212	Front Housing with parts	\$ 26.78
C101247	PCB	\$ 20.36
C101248	Thumbscrew, Saber	\$ 5.24
C101249	PCB	\$ 20.36
C101250	Thumbscrew, Jaguar 700P	\$ 5.24
C101251	PCB	\$ 20.36
C101252	PCB	\$ 20.36
C302370	Thumbscrew, Maxon SP200	\$ 5.24
C302400	Thumbscrew Icom F30G/F40G and F50/F60	\$ 5.24
C302551	Thumbscrew, HT750	\$ 4.37
C303175	Thumbscrew, TK480	\$ 4.37
C303211	Thumbscrew, Icom F21/F43	\$ 5.24
C401401-10	Earphone jack cover (10 per bag)	\$ 8.44
C705007-02	Thumbscrew, VX800	\$ 5.24
V3-10022	MRK coil cord cable assembly	\$ 68.35
V3-10023	MRK coax straight cable assembly	\$ 72.78
V3-10024	MPA / MPD coil cord cable assembly	\$ 57.26
V3-10025	MPA / MPD coax straight cable assembly	\$ 67.80
V3-10026	PCS coil cord cable assembly	\$ 57.26
V3-10027	KPC / Panther 500P coil cord cable assembly	\$ 56.43
V3-10032	Monogram and Maxon SP-2550 series coil cord cable assy.	\$ 56.43
V3-10039	GP300 coil cord cable assembly	\$ 33.30
V3-10040	Kenwood TK250 series coil cord cable assembly	\$ 36.80



Pricing for Evolution Remote Speaker Microphone Replacement Parts

PART NUMBER	DESCRIPTION	SUGGESTED RESALE
V3-10043	HT1000 coil cord cable assembly	\$ 63.33
V3-10044	Relm coil cord cable assembly	\$ 65.03
V3-10046	Maxon SP120 series coil cord cable assembly	\$ 36.80
V3-10046	Vertex VX-500 coil cord assembly	\$ 36.80
V3-10061	Prism / LPE coil cord cable assembly	\$ 68.35
V3-10062	Prism / LPE straight cable assembly	\$ 72.78
V3-10082	Kenwood TK290/390/480/481 coil cord cable assembly	\$ 63.21
V3-10084	Icom F3/F3S/F4/F4S coil cord assembly	\$ 35.42
V3-10086	Vertex VX-10 coil cord assembly	\$ 31.26
V3-10104	MRK coil cord cable assembly with earphone jack in UDC	\$ 61.16
V3-10198	Jaguar 700P coil cord cable assembly	\$ 68.35
V3-10199	Jaguar 700P coax straight cord cable assembly	\$ 72.78
V3-10200	Jaguar 700P coax coiled cord cable assembly	\$ 90.23
V3-10209	EDACS 300P coil cord cable assembly	\$ 68.35
V3-10216	Icom F30G / F40G coil cord assembly	\$ 48.31
V3-10230	Vertex VX-210 / VX-400 coil cord assembly	\$ 31.27
V3-10237	MRK coax coil cable assembly	\$ 90.23
V3-10244	Prism / LPE straight cable assembly	\$ 90.23
V3-10253	HT750/HT1250 coil cord cable assembly	\$ 63.33
V3-10262	Icom F3G/F3GS/F4G/F4GS/F11/F21	\$ 35.42
V3-10274	HT1000 Straight Coax Cable	\$ 72.78
V3-10275	HT1000 Coil Coax Cable	\$ 92.98
V3-10276	Kenwood TK290/390 Coil Coax Cable	\$ 59.94
V3-10277	Vertex VX800/VX900 coil cord assembly	\$ 60.26
V3-10278	MPA/MPD Coil Coax Cord with Emergency Button	\$ 77.91
V3-10282	Maxon SP200/210 coil cord cable assembly	\$ 36.79
V3-10283	HT1000 coil cord cable and emergency button	\$ 71.20
V3-10284	HT1000 Coil Coax Cable with Emergency Button	\$ 98.11
V3-10288	Saber / Astro coil cord cable assembly	\$ 63.33
V3-10310	Kenwood TK480 Coil Coax Cable assembly	\$ 59.94
V3-10346	Icom F50/F60 coil cord assembly	\$ 53.31
V3-10368	Simco/Sepura SRP8000 coil cord assembly	\$ 35.80

## Genesis Speaker Microphone Replacement Parts

Speaker Microphone Model	Back Housing Assembly	Debris Screen	Grill Insert and Gasket	Thumbscrew	Cable Assembly
Icom F30G/F40G Series Coil Cord (V2-G2CD211)	C101172	C101271	C101178	C302400	TBD
Icom F30G/F40G Series Coil Cord & Emerg Btn (V2-G2CD221)	C101172	C101271	C101178	C302400	TBD
Icom F30G/F40G Series Coil Cord & Acc Jack (V2-G2CD311)	C101172	C101271	C101178	C302400	TBD
Icom F30G/F40G Series Coil Cord, Emerg Btn & Acc Jack (V2-G2CD321)	C101172	C101271	C101178	C302400	TBD
Icom F50/F60 Series Coil Cord (V2-G2CE211)	C101172	C101271	C101178	C302400	V3-10371
Icom F50/F60 Series Coil Cord & Acc Jack (V2-G2CE311)	C101172	C101271	C101178	C302400	V3-10371
Icom F50/F60 Series Coil Cord & Emerg Btn (V2-G2CE221)	C101172	C101271	C101178	C302400	TBD
Kenwood TK480 Coil Cord (V2-G2KB211)	C101172	C101271	C101178	C303175	V3-10271
Kenwood TK480 Coil Cord & Acc Jack (V2-G2KB311)	C101172	C101271	C101178	C303175	V3-10271
Kenwood TK480 Coil Cord, Emerg Btn & Acc Jack (V2-G2KB321)	C101172	C101271	C101178	C303175	TBD
M/A-COM Jaguar 700P Coil Cord (V2-G2EJ211)	C101172	C101271	C101178	C101250	TBD
M/A-COM Jaguar 700P Coil Cord & Emerg Btn (V2-G2EJ221)	C101172	C101271	C101178	C101250	V3-10268
M/A-COM Jaguar 700P Str.Coax, Ant Port and Emerg Btn (V2-G2EJ223)	C101172	C101271	C101178	C101250	V3-10269
M/A-COM Jaguar 700P Coil Coax, Atn Port and Emerg Btn (V2-G2EJ222)	C101172	C101271	C101178	C101250	V3-10270
M/A-COM Jaguar 700P Coil Cord, Emerg Btn & Acc Jack(V2-G2EJ321)	C101172	C101271	C101178	C101250	V3-10268
M/A-COM Jaguar 700P Str.Coax, Emerg Btn and Acc Jack (V2-G2EJ323)	C101172	C101271	C101178	C101250	V3-10269
M/A-COM Jaguar 700P Coil Coax, Emerg Btn and Acc Jack (V2-G2EJ322)	C101172	C101271	C101178	C101250	V3-10270
M/A-COM MRK Coil Cord (V2-G2EC211)	C101172	C101271	C101178	C100649	V3-10266
M/A-COM MRK Coil Cord & Acc Jack (V2-G2EC311)	C101172	C101271	C101178	C100649	V3-10266
M/A-COM PRISM/LPE Coil Cord (V2-G2ED211)	C101172	C101271	C101178	C100649	V3-10267
M/A-COM PRISM/LPE Coil Cord & Acc Jack (V2-G2ED311)	C101172	C101271	C101178	C100649	V3-10267
M/A-COM PRISM/LPE Coil Coax,Atn Port and Emerg Btn (V2-G2ED222)	C101172	C101271	C101178	C100649	TBD
Motorola GP300 Series Coil Cord (V2-G2MG211)	C101172	C101271	C101178	N/A	V3-10272
Motorola HT1000 Series Coil Cord (V2-G2MA211)	C101172	C101271	C101178	N/A	V3-10263
Motorola HT1000 Series Str.Coax, Ant Port (V2-G2MA213)	C101172	C101271	C101178	N/A	V3-10264
Motorola HT1000 Series Coil Coax, Ant Port (V2-G2MA212)	C101172	C101271	C101178	N/A	V3-10265
Motorola HT1000 Series Coil Cord & Emerg Btn (V2-G2MA221)	C101172	C101271	C101178	N/A	V3-10281
Motorola HT1000 Series Str.Coax, Ant Port and Emerg Btn (V2-G2MA223)	C101172	C101271	C101178	N/A	V3-10309
Motorola HT1000 Series Coil Coax, Atn Port and Emerg Btn (V2-G2MA222)	C101172	C101271	C101178	N/A	V3-10280
Motorola HT1000 Series Coil Cord & Acc Jack (V2-G2MA311)	C101172	C101271	C101178	N/A	V3-10263
Motorola HT1000 Series Str.Coax, Ant Port and Acc Jack (V2-G2MA313)	C101172	C101271	C101178	N/A	V3-10264
Motorola HT1000 Series Coil Coax, Acc Jack & Ant Port (V2-G2MA312)	C101172	C101271	C101178	N/A	V3-10265
Motorola HT1000 Series Coil Cord, Acc Jack & Emerg.Btn (V2-G2MA321)	C101172	C101271	C101178	N/A	V3-10281
Motorola HT1000 Str.Coax, Ant Port, Emerg Btn and Acc Jack (V2-G2MA323)	C101172	C101271	C101178	N/A	V3-10309
Motorola HT1000 Coil Coax, Ant Port, Emerg Btn and Acc Jack (V2-G2MA322)	C101172	C101271	C101178	N/A	V3-10280
Motorola HT750 / HT1250 Coil Cord (V2-G2MJ211)	C101172	C101271	C101178	C302551	V3-10314
Motorola HT750 / HT1250 Coil Cord and Acc Jack (V2-G2MJ311)	C101172	C101271	C101178	C302551	V3-10314
Motorola Saber / Astro Coil Cord (V2-G2MC211)	C101172	C101271	C101178	N/A	V3-10315
Motorola Saber / Astro Coil Cord and Acc Jack (V2-G2MC311)	C101172	C101271	C101178	N/A	V3-10315
Relm Wireless Coil Cord (V2-G2BA211)	C101172	C101271	C101178	N/A	TBD
Tait Orca Coil Cord (V2-G2MG211)	C101172	C101271	C101178	N/A	V3-10272
Vertex VX800 Coil Cord (V2-G2VF211)	C101172	C101271	C101178	C705007-02	V3-10316

**Pricing for Genesis Remote Speaker Microphone Replacement Parts**

PART NO.	DESCRIPTION	SUGGESTED RESALE
C302400	Thumbscrew, Icom F30G/F40G Sereis	\$ 5.23
C101250	Thumbsrew, Jaguar 700P	\$ 5.24
C100649	Thumbscrew, MRK	\$ 5.11
C302551	Thumbscrew, HT750 Series	\$ 4.37
C303175	Thumbscrew, Kenwood TK480	\$ 4.37
C705007-02	Thumbscrew, VX800	\$ 5.24
C101172	Back Cover/Speaker Pad	\$ 22.35
C101178	Replaceable Grill Insert and Gasket	\$ 3.50
C101271	Replaceable Debris Screen	\$ 5.99
V3-10263	HT1000 series coil cord assembly	\$ 65.81
V3-10264	HT1000 series straight coax cable assembly	\$ 75.03
V3-10265	HT1000 series coil coax cable assembly	\$ 92.05
V3-10266	MRK coil cord assembly	\$ 70.71
V3-10267	Prism / LPE coil cord assembly	\$ 70.71
V3-10268	Jaguar 700P coil cord assembly	\$ 70.71
V3-10269	Jaguar 700P straight coax cable assembly	\$ 75.03
V3-10270	Jaguar 700P coil coax cable assembly	\$ 92.05
V3-10271	Kenwood TK480 series coil cord assembly	\$ 65.69
V3-10280	HT1000 series coil coax cable assembly	\$ 92.05
V3-10281	HT1000 series coil cord assembly	\$ 65.81
V3-10309	HT1000 series straight coax cable assembly	\$ 75.03
V3-10314	HT750 / HT1250 series coil cord assembly	\$ 62.81
V3-10315	Saber / Astro coil cord assembly	\$ 65.81
V3-10316	Vertex VX800 seres coil cord assembly	\$ 62.81
V3-10371	ICOM F50/F60 coil cord assembly	\$ 57.31

